

Software Manual

Program EWS

Version 4.7

Calculation of Borehole Heat Exchangers

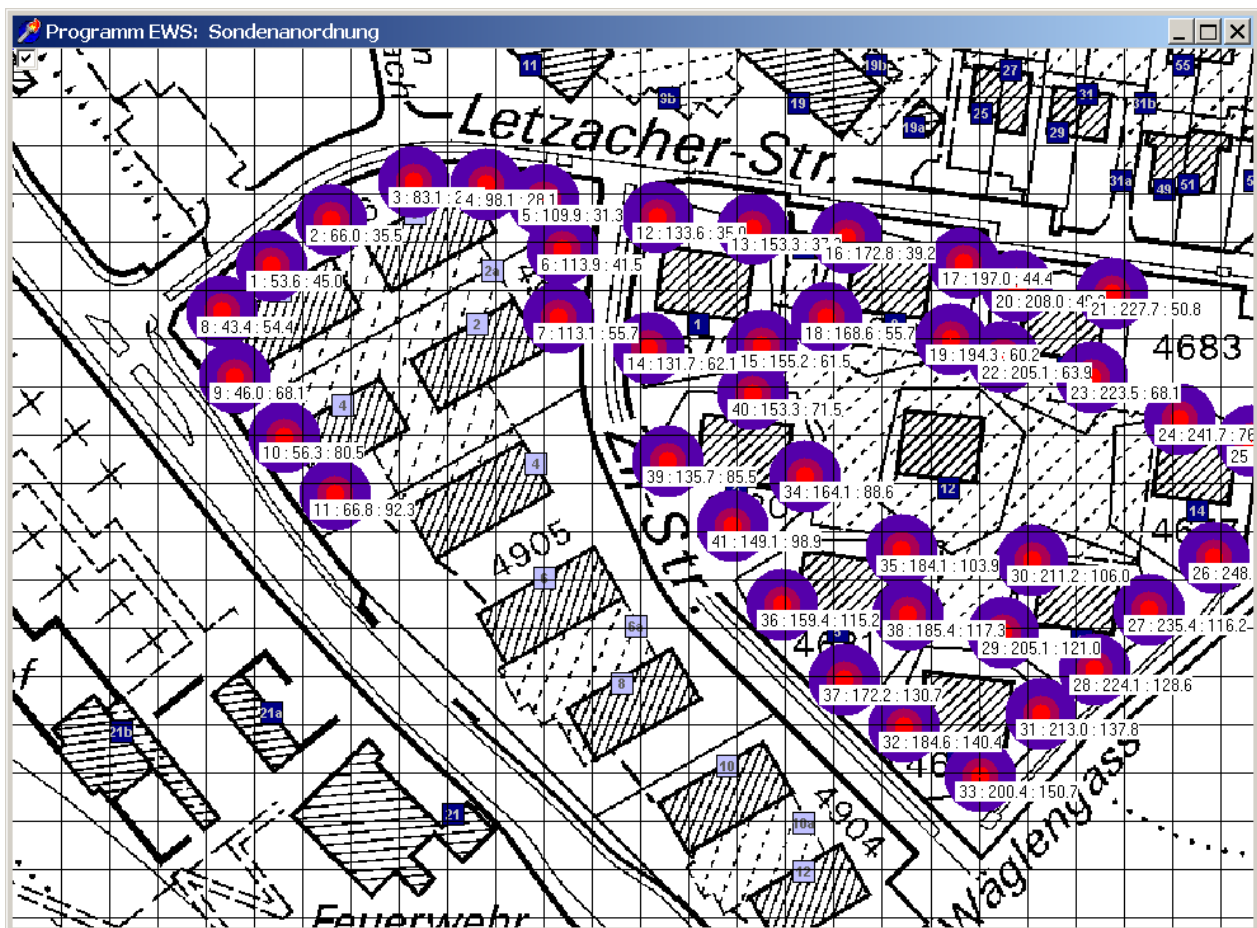

Arthur Huber

September 2011

Table of contents

1	Software Manual.....	4
1.1	Content and use of the program EWS.....	4
1.2	The structure of the manual.....	4
1.3	What is new in the version 4.7.....	4
1.4	Further literature.....	4
2	Installation and licensing.....	5
2.1	System requirements.....	5
2.2	Program delivery.....	5
2.3	Language versions.....	5
2.4	Program licenses.....	5
2.5	Installation.....	6
2.6	Input of the license number.....	6
3	Data input.....	8
3.1	Basics of the data input.....	8
3.1.1	Missing file „Lizenz.ews“.....	8
3.1.2	Decimal points.....	8
3.1.3	Default values.....	8
3.1.4	Pull-down menus.....	8
3.2	The sheet “Boreholes”.....	9
3.2.1	Selection of the borehole type.....	10
3.2.2	Boreholes with double-U-pipes.....	10
3.2.3	Coaxial pipe-systems.....	11
3.2.4	Selection of the borehole configuration (single borehole or field of boreholes).....	12
3.2.5	Input of a particular g-function.....	14
3.3	A freely designed borehole configuration: The sheet „Field of boreholes“.....	16
3.3.1	Set, dislocate and delete boreholes in a field of boreholes.....	17
3.3.2	Inserting a background-map in 4 easy steps:.....	18
3.3.3	Optimization of borehole fields.....	19
3.4	Calculation of a single borehole in a field of boreholes.....	19
3.5	The sheet “Fluid”.....	20
3.5.1	The temperatures in the undisturbed earth.....	21
3.5.2	Automatically calculated borehole length.....	22
3.6	The sheet “Info”.....	22
3.7	The sheet “Earth”.....	23
3.7.1	Basic Inputs.....	23
3.7.2	Input of multiple horizontal layers.....	25
3.7.3	Physical properties of the earth.....	26
3.7.4	Creation of a user defined geological library.....	27
3.8	The sheet “Extraction”.....	29
3.9	The sheet “Load”.....	31
3.10	The sheet “Simulation”.....	33
3.10.1	The sheet “Simulation”.....	33
3.10.2	Input of the heat extraction rate and the borehole inlet temperature.....	34

3.10.3	The active, additional cooling if freecooling is not sufficient.....	34
3.10.4	Antifreeze (minimal brine temperature) und bivalent heat pump systems.....	34
3.10.5	The response test.....	34
3.11	The sheet "Parameter"	36
3.12	The sheet "Pressure"	37
3.13	Properties of the heat pump and of the supplementary heating system.....	39
3.14	Direct cooling	40
4	Calculations	42
4.1	Diagram of the inlet and outlet temperature of the borehole fluid.....	42
4.2	The diagram of the heat extraction rate.....	42
4.3	The sheet "Results"	43
5	ANNEX A: Description of the model	44
5.1	Simulation area.....	44
5.1.1	The simulation of the time step	45
5.2	Calculation grid.....	46
5.3	Heat Equation and the thermal response g	47
5.3.1	Heat Equation.....	47
5.3.2	The radial temperature funnel	47
5.3.3	The dimensionless thermal response g.....	48
5.3.4	The comparison of the models	49
5.4	The calculation of the g-function with the principle of superposition.....	50
5.5	The borehole temperature T_b and the fluid temperature T_f	50
5.5.1	The fluid temperature T_f	51
5.6	Thermal resistances R_a und R_b in the double-U-pipe	51
5.6.1	The internal borehole resistance R_a by Hellström [4]	52
5.6.2	The borehole resistance R_b by Hellström [4]	52
5.7	Thermal resistances R_a / R_b of a coaxial borehole	53
5.7.1	Modeling of the intern borehole resistance R_a	53
5.7.2	Modeling of the borehole resistance R_b	53
5.8	The analytical borehole equation.....	54
5.8.1	The concept of thermal resistances	54
5.8.2	Thermal resistance R_f (evaporator)	54
5.8.3	Thermal resistance R_m (temperature loss along the borehole).....	55
5.8.4	Thermal resistance of the earth R_g	56
5.8.5	The analytical borehole equation	56
6	ANNEX B: Input of a particular g-function	57
6.1	Example 1: The input of a g-function by the values of the function	57
7	Table of symbols.....	59
7.1	Latin symbols.....	59
7.2	Greek symbols.....	60
8	Literature.....	60

1 Software Manual

1.1 Content and use of the program EWS

The basic version of the program EWS calculates the behavior of borehole heat exchangers. This is done by solving numerically the heat equation of the ground and the heat transfer from the boreholes. The program calculates the outlet and inlet temperatures as well as the heat extraction rate of the boreholes (single boreholes or fields of boreholes) with hourly time steps up to a period of 60 years. The program EWS allows to take into account all major impacts. The ground can be divided into maximal 10 layers with different types of ground materials and the corresponding properties. Since the program EWS is able to do unsteady calculations of the fluid, it offers the possibility to calculate “start-up processes” and “thermal response tests”.

Furthermore, the full extension of the program EWS is able to calculate direct cooling systems with borehole heat exchangers, where the boreholes can be placed in random arrangements direct on the screen. Based on the return temperature of the building’s cooling system (TABS, cooling ceiling and ventilation), it is possible to simulate an hydraulic linking of the borehole heat exchanger with the ventilation or the hydraulic cooling system. Even simulations with complex ventilation schedules are feasible. Outdoor air temperatures can be read from a meteorological data base (e.g. Meteonorm) in hourly time steps.

1.2 The structure of the manual

The present manual guides the user through the different input masks of the program EWS and learns him how to use them properly. It is presumed that the user is basically grounded in physic values. Therefore, the physical values are not introduced.

In the first part, the user will be familiarized with the input data. In the second part, the manual gives information about the calculation procedure.

1.3 What is new in the version 4.7

The following new features are implemented in the version 4.7: Possibility to insert a scaled background map to simplify the input of the borehole configuration, optimal borehole length is calculated automatically according to the norm SIA 384/6, the undisturbed temperature profile in the earth can be entered (starting condition for the simulation in up to 10 layers), possibility for a free arrangement for up to 100 boreholes in a field; calculation of the pressure loss for the hole borehole heat exchanger system; new worksheet “load profile” that allows the input of the monthly heating and cooling energy demand as well as the heat demand for the tap water of the building; new input for geological profiles with unequal layers and the possibility to create a user-defined library of geological data.

1.4 Further literature

During the elaboration of the program EWS it was paid highly attention to the fact, that users with no deeper comprehension of the models should be able to use the program. Hence a default value for each set of input is provided. In most cases these default values lead to reasonable results. The manual does not present all the models that are used in the code. But these models are published in very detailed manner (sometimes even with source code of the program) in scientific reports and publications. An overview of the publications can be found in the reference list.

The program EWS contains the EWS module, which was supported by the Swiss Federal Office of Energy (ref. [5], [6], [8]).

2 Installation and licensing

2.1 System requirements

The following requirements must be fulfilled to ensure a smooth use of the program EWS on your personal computer:

- processor: at least Pentium 800 MHz
- operating system: Windows 2000 / Windows XP / Windows Vista / Windows 7
- free disk space: at least 20 MB
- screen resolution: at least 1024 x 768 pixel

2.2 Program delivery

For legal reasons the program EWS will not be delivered on a physical data medium. It can only be downloaded from the internet or sent by email. It must be unlocked with a license number.

2.3 Language versions

The program EWS is available in different language versions (English, German, French, Italian, Spanish). The language can be changed anytime by selecting the favored language in the pull-down menu "info".

2.4 Program licenses

The acquisition of a program license authorizes to the installation of the program EWS on one computer of the client. It is feasible to obtain a second license number for a second working station (e.g. laptop, home computer) without additional charge if the computer is exclusively used by one person. In the case of the substitution of the old computer it can be applied for a third license.

In all other cases, supplementary program licenses must be purchased for additional installations.

Program licenses are unassignable and must not be resold.

Schools get special conditions. School licenses are not allowed to be used for commercial calculations.

2.5 Installation

The program EWS requires no installation. Just copy the file “Ews.exe” into your favored program folder on the computer. The program EWS can be unlocked by the entry of the license number. Thereby, 3 types of license numbers are distinguished:

1. license number for test version (4701)
2. license number for a basic installation
3. license number for full version

According to the license number a different functional range is available.

2.6 Input of the license number

The test version, as well as the basic version and the full version must be unlocked by the input of a license number. The corresponding procedure is described in the following:

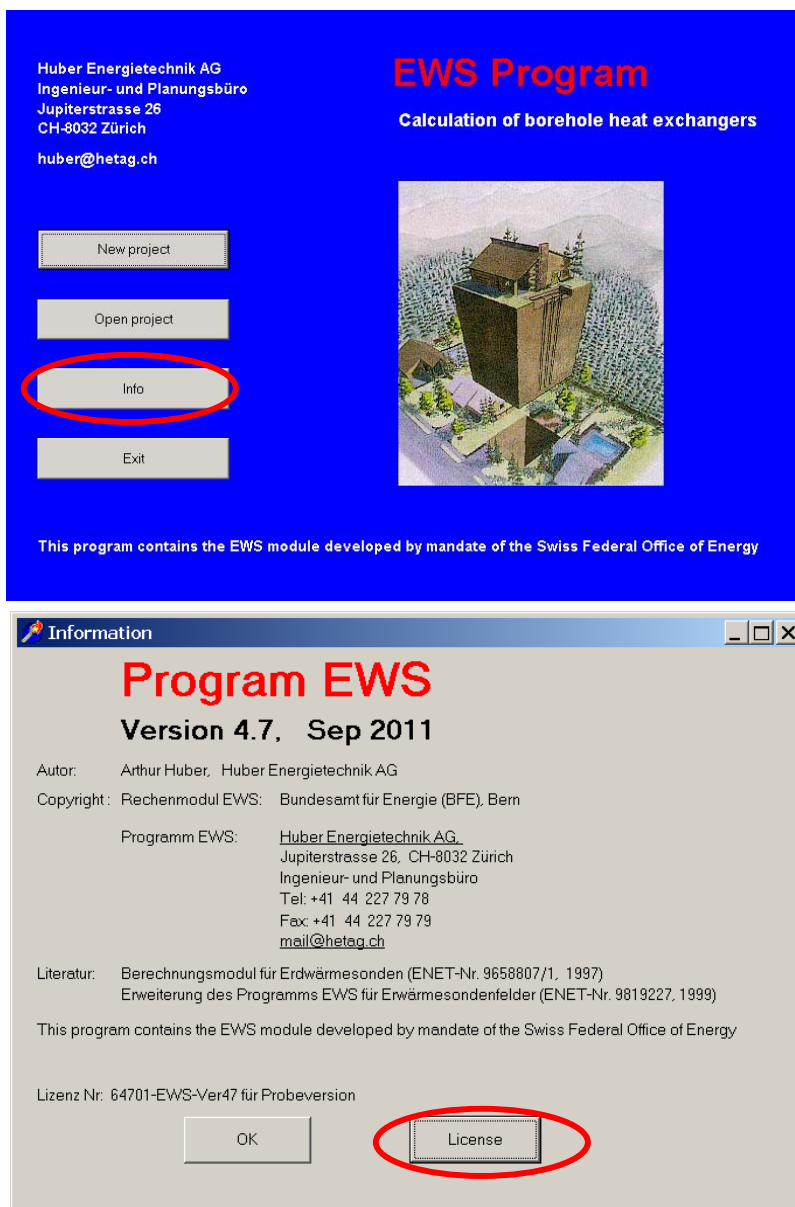

Test version:

The word “Probeversion” must be written in the designated field instead of the company name to unlock the test version. The license number of the test version is **4701**.

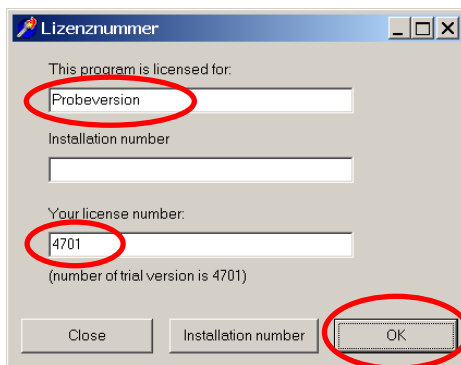

The test version offers to everybody the complete functional range of the full program version. But there are some restrictions to a part of entries that can not be changed (e.g. length of the boreholes, substance properties,...).

Basic and full version:

The installation number is shown by pushing the button “Installation number”. This number has a particular value for each personal computer. This number has to be sent together with the name of the company by e-mail to mail@hetag.ch. The individual license number will be sent back to you within 48 hours.

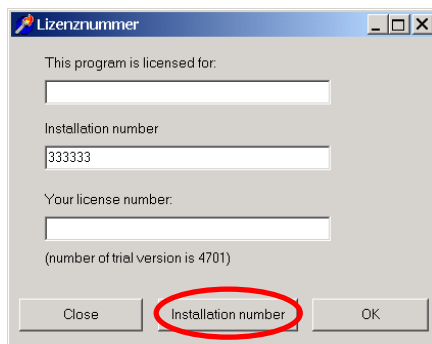

The license number and the company name should be entered into the designated fields. Keep the license number safe since after a certain time it might be necessary to enter the license number again.

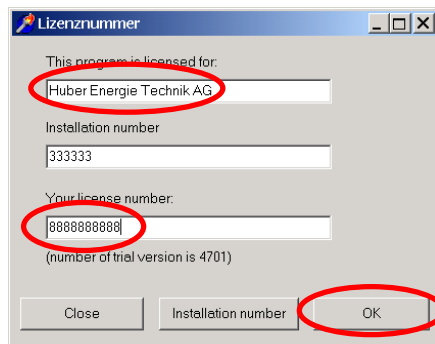

After the finalization of the installation it is necessary to do one calculation with the program EWS by using its unchanged default values. Only now it can be continued with the data input.

3 Data input

3.1 Basics of the data input

3.1.1 Missing file „Lizenz.ews“

There is no license number entered yet (see chapter 2.6) if the following error message appears during the start up of the program.

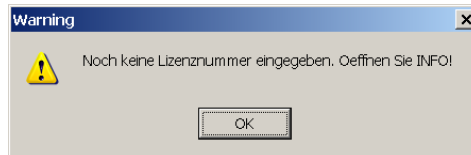

If you have already entered the license number and the error message still appears, please assure that the file „Lizenz.ews“ is in the same folder as the program „Ews.exe“. Is this not the case, copy the file „Lizenz.ews“ into the current program folder or enter the license number once more according to chapter 2.6.

3.1.2 Decimal points

It is important that inputs are always entered with decimal points and never with decimal commas. All input information after a decimal comma is ignored by the program and may produce the error message „Floating point division by zero“.

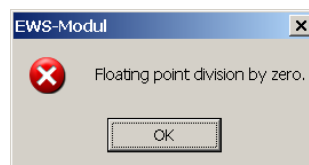

3.1.3 Default values

A default value is allocated for each parameter at the start up of the program. These values were chosen carefully with the aim to represent the most common cases. Generally, it can be calculated with the default value if a simulation parameter is unknown or the sense of a parameter is unclear.

3.1.4 Pull-down menus

Various input fields offer a pull-down menu as a help for the data input. Normally, several input parameters are set to the corresponding values by the selection of an option in the pull-down menu. Nevertheless, please note that these input values can be changed manually afterwards. In such a case it may happen that the input values do not agree anymore with the pull-down menu. The EWS Program deals with this inconsistency by using the manually entered values and by ignoring the pull-down selection.

→ **Generally, the EWS Program does not calculate with the values from the selection in the pull-down menu, but always with input field associated to the input parameter. These input fields can be changed in every case independently from the pull-down menu.**

3.2 The sheet “Boreholes”

The number of boreholes, the borehole depth H, the type of the boreholes and the configuration of the boreholes can be defined in the sheet “Boreholes”.

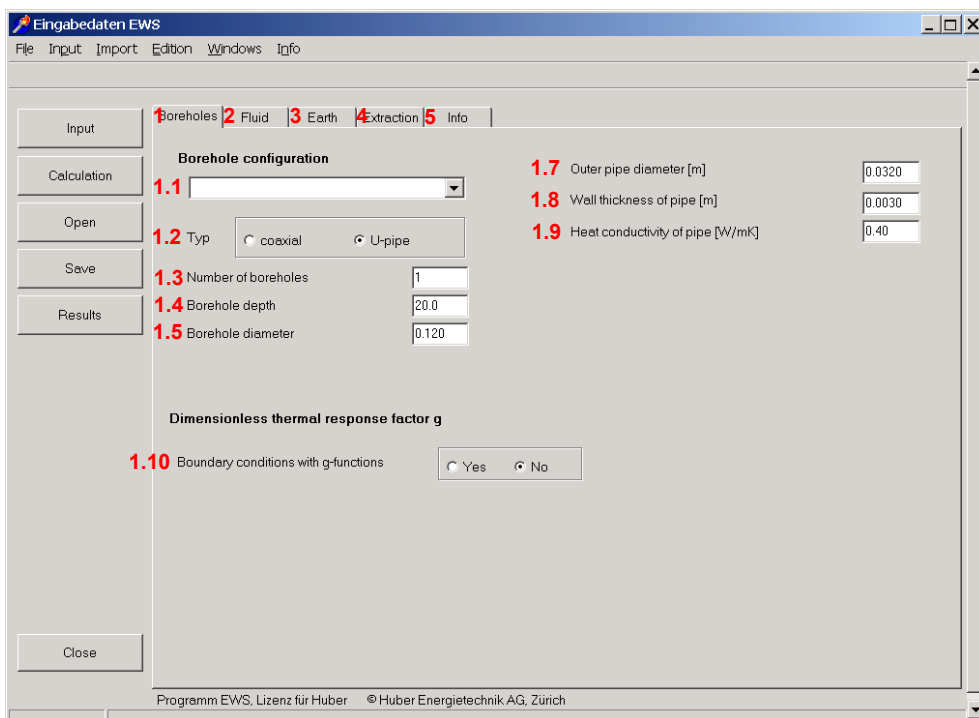

Fig. 3.1: The sheet “Boreholes” and its default values.

In field 1.4 you enter the depth of the boreholes and in field 1.3 the number of boreholes. Additional input fields appear (see Fig. 3.2), if more than one borehole is entered in the field 1.3. Furthermore, the borehole distance can be entered in field 1.6 and in field 1.11 it is possible to choose the borehole configuration.

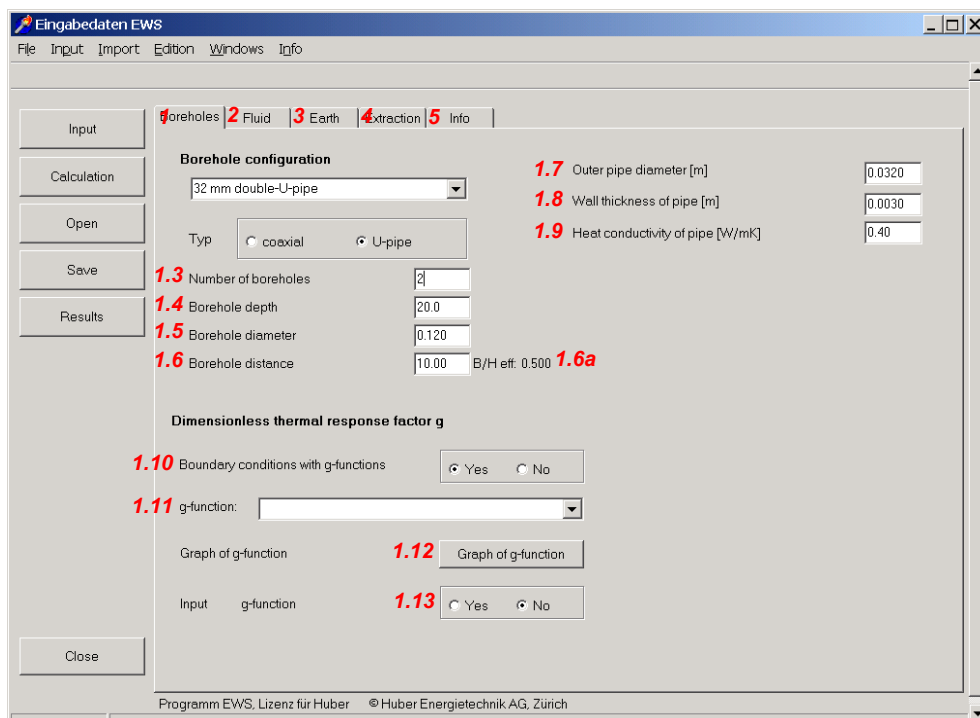

Fig. 3.2: On the sheet “Boreholes” additional input fields appear, if 2 or more boreholes are entered in field 1.3

3.2.1 Selection of the borehole type

By selecting one of the options in the pull-down field 1.1 (see Fig. 3.3) the program fills in automatically the default values for the borehole type (double-U- or coaxial pipes, field 1.2), the borehole diameter [$2 \times r_1$] (field 1.5), the outer pipe diameter [$2 \times r_s$] (field 1.7), the wall thickness of the pipe [$r_s - r_o$] (field 1.8) and the heat conductivity of the pipe (field 1.9). But these parameters can still be adjusted manually.

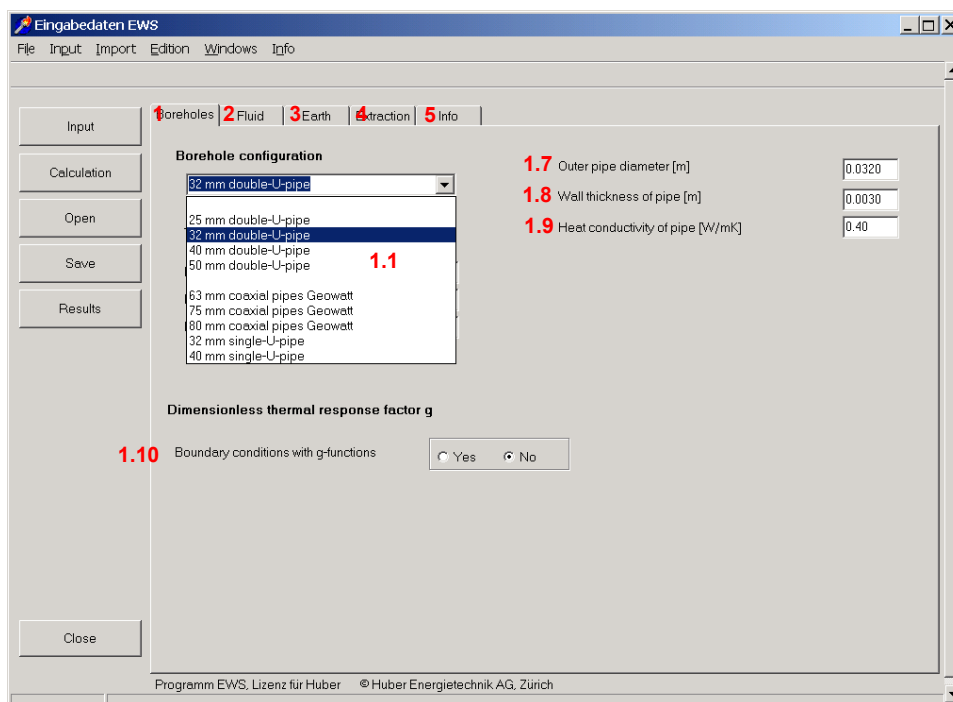

Fig. 3.3: The sheet “Boreholes” with its options to choose in field 1.1.

Especially for the borehole diameter there can be bigger deviations from the default value depending on the ground properties and the used drilling technology. Check the borehole diameter carefully (field 1.5).

3.2.2 Boreholes with double-U-pipes

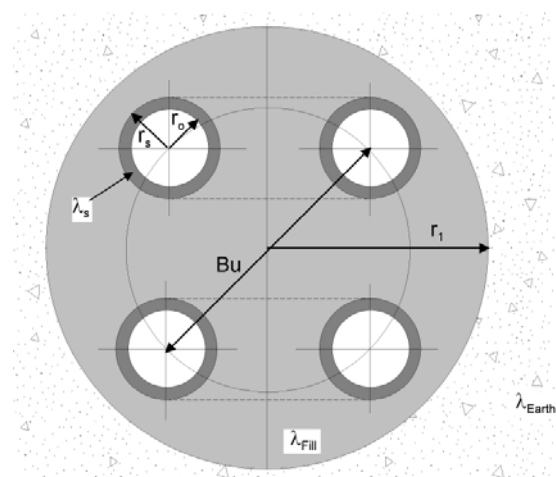

Fig. 3.4: Double-U-pipe’s nomenclatures.

The borehole disposition can be entered in the following manner:

- field 1.5 Borehole diameter = $2 \times r_1$
- field 1.7 Outer pipe diameter = $2 \times r_s$
- field 1.8 Wall thickness of the pipe = $r_s - r_o$
- field 1.9 Heat conductivity of the pipe λ_s
- field 3.11 Shank spacing = Bu
- field 3.3 Heat conductivity of the filling λ_{Fill}

3.2.3 Coaxial pipe-systems

The additional input fields 1.22, 1.23 and 1.24 appear if coaxial pipes are selected in field 1.2.

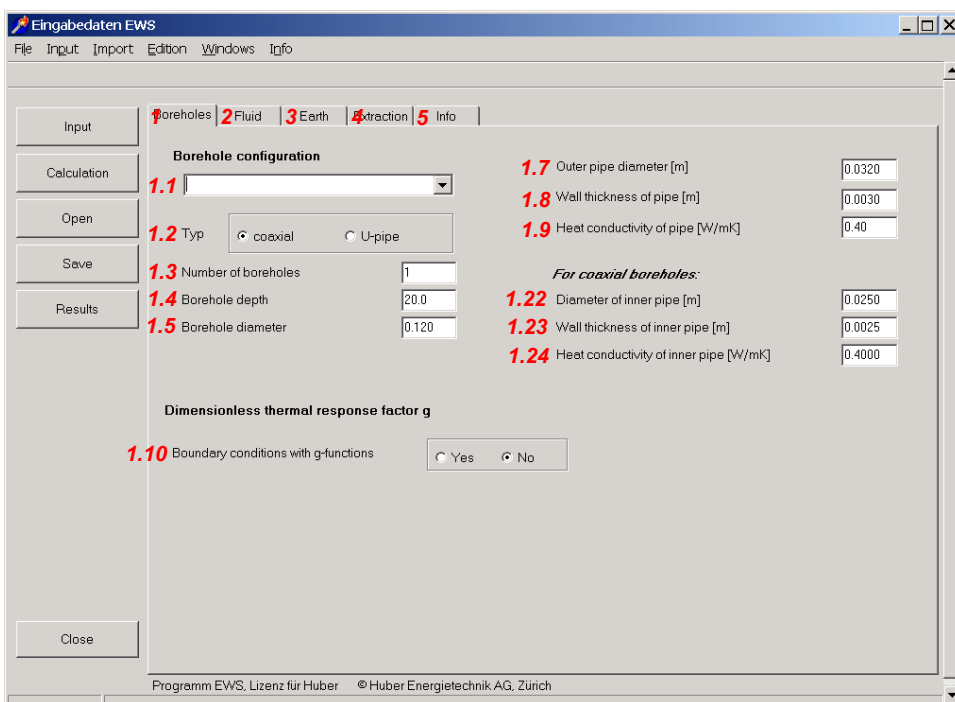

Fig. 3.5: The sheet “Boreholes”, selecting of coaxial pipes in field 1.2.

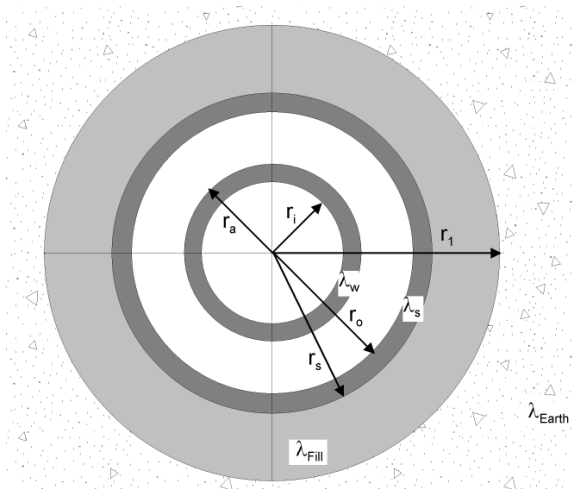

Fig. 3.6: Coaxial pipe’s nomenclatures.

The borehole disposition can be entered as following:

- field 1.5 Borehole diameter = $2 \times r_1$
- field 1.7 Outer pipe diameter = $2 \times r_s$
- field 1.8 Wall thickness of the pipe = $r_s - r_o$
- field 1.9 Heat conductivity of the pipe λ_s
- field 1.22 Diameter of the inner pipe = $2 \times r_a$
- field 1.23 Wall thickness of the inner pipe = $r_a - r_i$
- field 1.24 Heat conductivity of the inner pipe λ_w
- field 3.3 Heat conductivity of the filling λ_{Fill}

3.2.4 Selection of the borehole configuration (single borehole or field of boreholes)

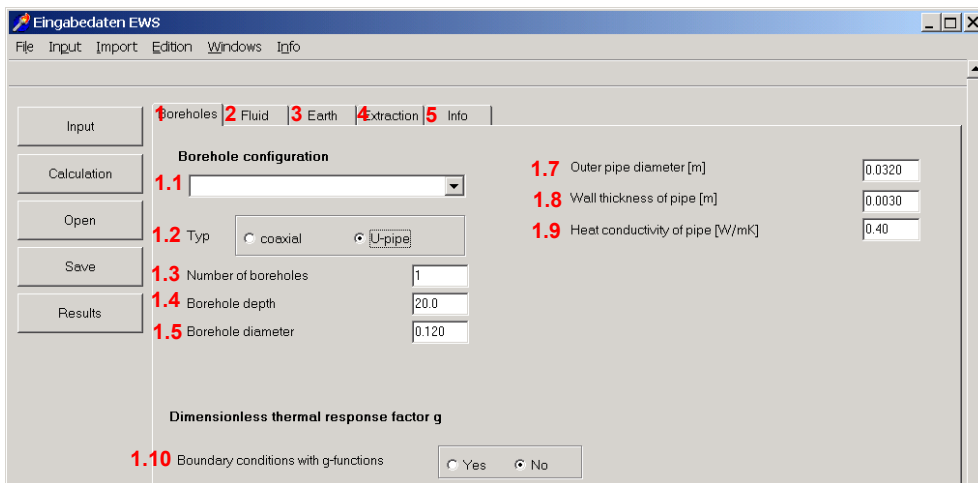

Fig. 3.7: The Sheet “Boreholes” with its default values.

Each type of borehole configuration can be described by its dimensionless thermal response function g (see eq. 5.8). The program EWS sets the outer boundary condition of the simulation area to this thermal response. For single boreholes, a second possibility is the use of the analytical solution for infinite line sources, described by Carslaw & Jaeger [1] (see eq. 5.11). Field 1.10 defines which solution is applied. The program EWS sets the boundary condition with the g -function, if the field 1.10 is set to “yes”, otherwise it uses the equation of Carslaw & Jaeger. The boundary condition calculated by Carslaw & Jaeger is only adequate for single boreholes and simulation periods up to the response time from eq. 5.12.

Once the entered number of boreholes (field 1.3) exceeds one, field 1.10 is set to “yes” and the boundary conditions are calculated with the g -functions ([2] and [3]). As a consequence the pull-down field 1.11 appears with a choice of the borehole configurations. There, B/H stands for the ratio of the borehole distance B and the borehole depth H.

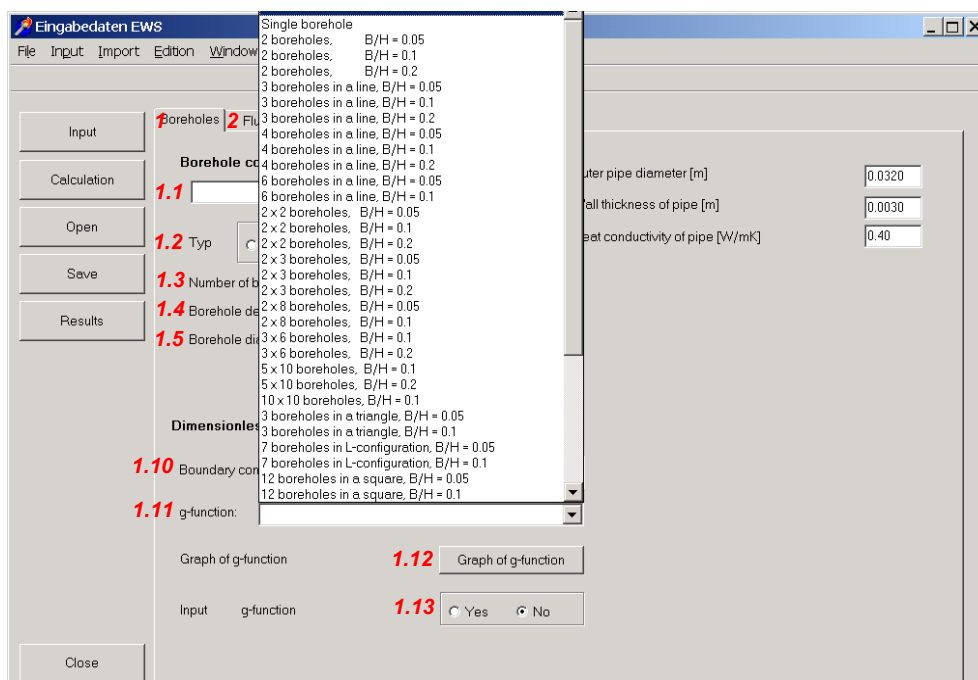

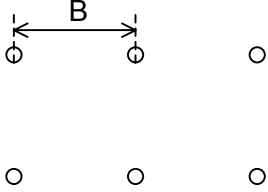
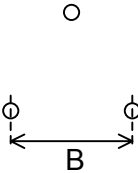
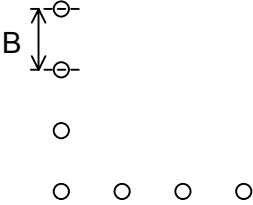
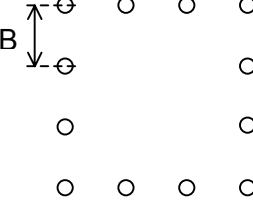
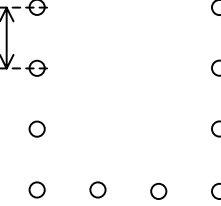

Fig. 3.8: The sheet “Boreholes” with the borehole configurations to choose from in field 1.11.

In the following the options for the borehole configuration in **field 1.11** are explained:

<ul style="list-style-type: none"> • „single borehole“: 	<p>The g-function for single boreholes by Eskilson is used.</p>
<ul style="list-style-type: none"> • 1 x n boreholes, e.g. 1 x 4 boreholes: 	
<ul style="list-style-type: none"> • m x n boreholes, e.g. 2 x 3 boreholes: 	
<ul style="list-style-type: none"> • 3 boreholes in a triangle: 	
<ul style="list-style-type: none"> • 7 boreholes in a L-shape: 	
<ul style="list-style-type: none"> • 12 boreholes in a square (around a building): 	
<ul style="list-style-type: none"> • 10 boreholes in a U-shape: 	
<ul style="list-style-type: none"> • „not defined“: 	<p>Each borehole is calculated with the equations by Carslaw & Jaeger (eq. 5.11) (single infinite line sources).</p>
<ul style="list-style-type: none"> • „special input“: 	<p>Description see chapter 3.2.5.</p>

Please pay attention to the following: The number in field 1.3 will not be adjusted automatically if the number of boreholes in the field 1.3 is not consistent with the selection in field 1.11! All calculations are always based on the value in field 1.3.

Each g-function is only valid for a special ratio of the borehole distance B to the borehole depth H. If the effective B/H_{eff} ratio (field 1.6a) differs from the B/H value of the selected g-function, the g-function will automatically be extrapolated to B/H_{eff} . This extrapolation is based on findings from Huber & Pahud [6]. Since all extrapolations are afflicted to an uncertainty, always use the g-function with the B/H ratio as close as possible to the effective value in the field 1.6.a. This extrapolated g-function, which is used for the calculation, will be shown graphically by pressing the button 1.12.

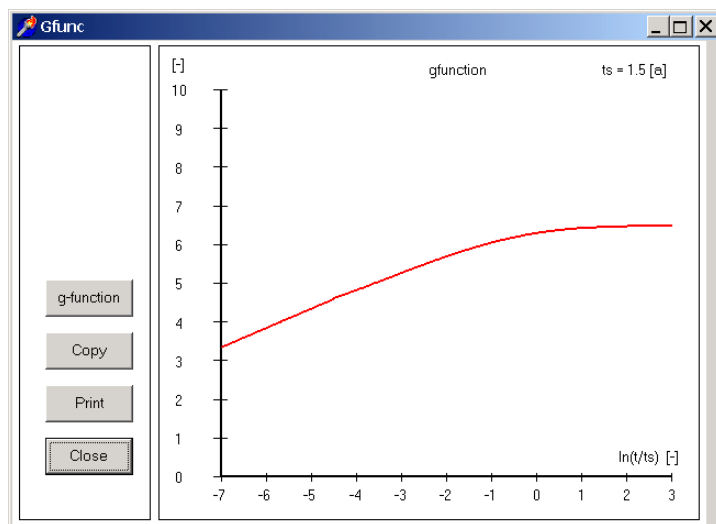

Fig. 3.9: The Sheet “Boreholes” with the graph of the extrapolated g-function.

3.2.5 Input of a particular g-function

The EWS Program offers the possibility to enter a particular g-function as an alternative to the selection of a borehole configuration from the library. There is a big number of published g-functions in the literature (e.g. [3]). Additionally, new g-functions can be interpolated from the existing library values. For instance, the borehole configuration 1 x 5 boreholes can be interpolated to a sufficient accuracy from the borehole configuration of 1x 4 and 1 x 6 boreholes.

In the following, it is shown how the user can enter a particular g-function. This is only necessary if the borehole configuration can not be described by one of the options in the field 1.11. To enter a g-function, chose “special input” in the field 1.11 and then select “yes” in the fields 1.10 and 1.13. Thereafter, the fields 1.14 to 1.21 (see Fig. 3.10) appear on the right hand side.

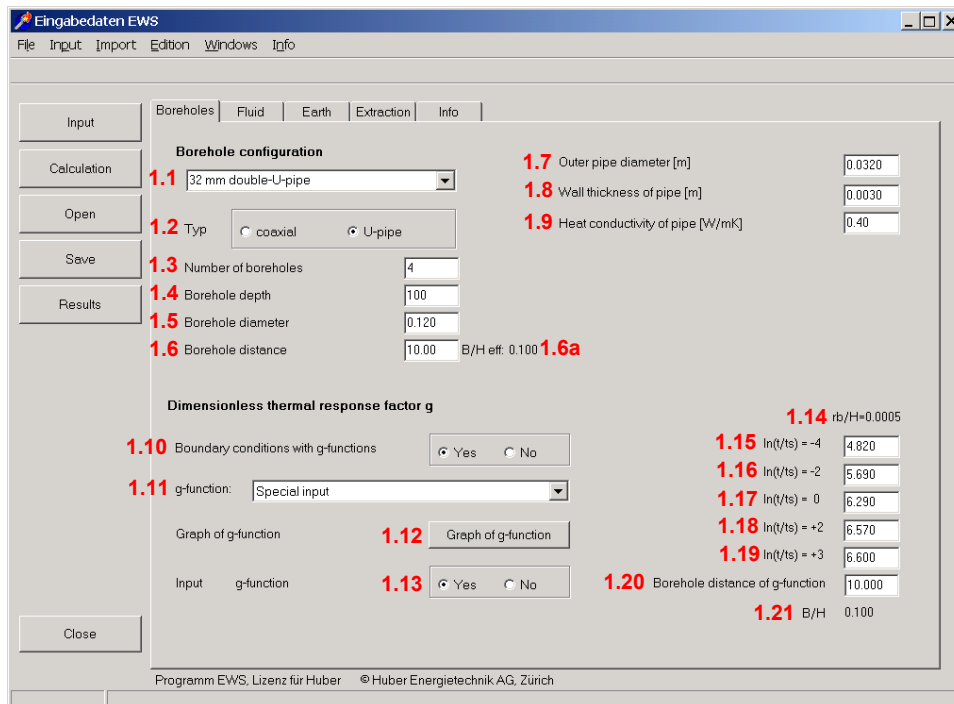

Fig. 3.10: The Sheet “Boreholes” during the input of a particular g-function.

The **fields 1.15 to 1.19** describe the g-function by giving the function values of the data points $\ln(t/t_s) = -4, -2, 0, +2, +3$. Published or self-calculated g-functions are always valid for a specific B/H ratio. The B/H ratio in the **field 1.21** is calculated from the borehole distance B (**field 1.20**) and the borehole depth H (**field 1.4**). First, the field 1.21 must be harmonized with the B/H ratio of the favored g-function. This can be done by adjusting the field 1.20 (The borehole depth in the field 1.4 must not be changed). Thereafter, the function values of the favored g-function on the data points $\ln(t/t_s) = -4, -2, 0, +2, +3$ are entered in the fields 1.15 to 1.19. The g-function is now completely defined by the fields 1.15 to 1.21.

Remarks:

- **Field 1.14** shows the ratio of the borehole radius r_b and the borehole depth H. This ratio is 0.0005 for all g-functions in the program library (and for most of the published g-functions). It can not be changed and it is published to the sake of completeness.
- It is still the effective ratio B/H_{eff} from the field 1.6a (and not the B/H ratio from the field 1.21) that defines the result of the calculation. During the next calculation, the EWS Program will automatically extrapolate the entered g-function to the effective B/H_{eff} ratio.
- If the g-function was entered under "special input" in the field 1.11 as described above, this g-function can be saved and later be reloaded from the option "special input".
- More detailed information about the g-function can be found in the ANNEX.

3.3 A freely designed borehole configuration: The sheet „Field of boreholes“

Only in the complete version of the program EWS, an additional, smart option is offered to enter any kind of borehole configurations up to 100 boreholes in a field. To take advantage of this option choose “Field of boreholes” in the menu “Input”(see Fig. 3.11).

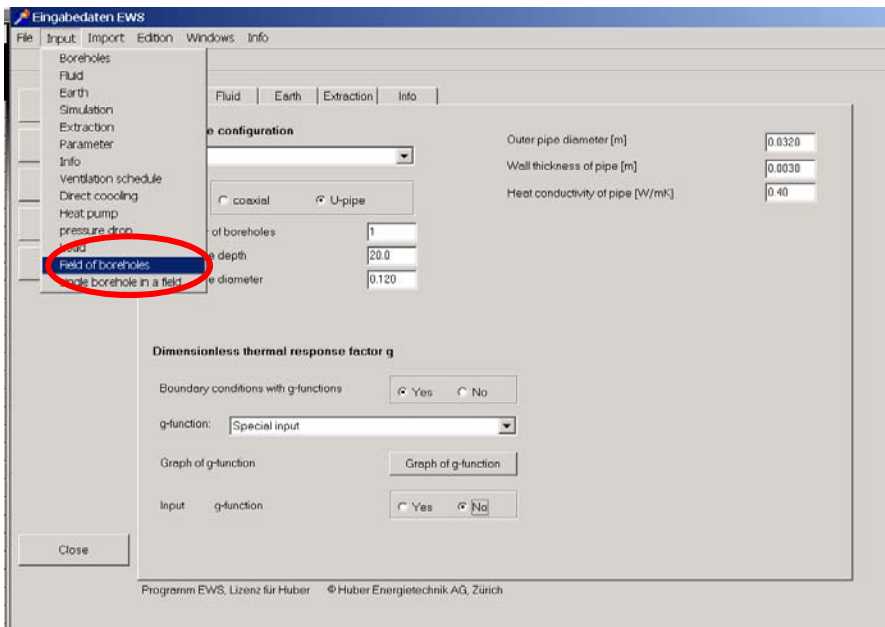

Fig. 3.11: The selection of the sheet “Field of boreholes” in the menu “input”

The full version of the program EWS now shows the sheet “Field of boreholes” with a grid. The distance between two grid lines is one meter. Every ten meter there is a thicker grid line. The grid lines correspond to a net of coordinates in which the left, upper corner has the coordinates 0/0.

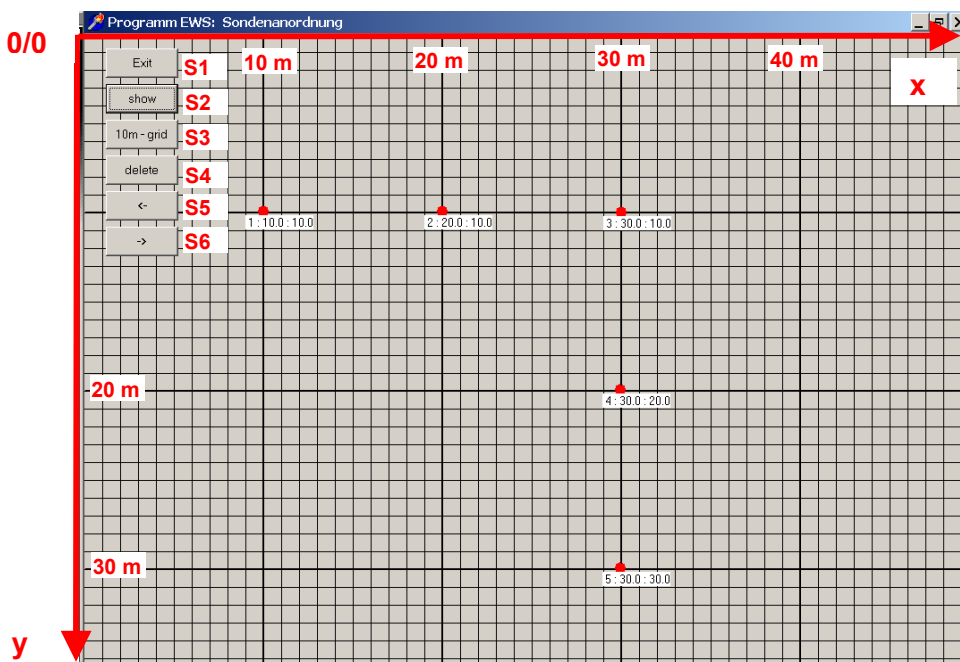

Fig. 3.12: The Sheet “Field of boreholes” with the grid (1 line per meter).

3.3.1 Set, dislocate and delete boreholes in a field of boreholes

It is possible to freely locate up to 100 boreholes on a field of boreholes by clicking with the left mouse button. Directly below each of the boreholes appears the borehole number (counting up from one in the order of the borehole setting), followed by the x-coordinate and the y-coordinate of the borehole. The x-coordinate and the y-coordinate correspond to the distance in meter from the left, upper corner of the grid. With the button **S4** the grid spacing can be changed from 1 m to 10 m. Each borehole can be set with a precision of 10 cm and can be **dislocated** anytime. To dislocate the borehole, select the centre of the borehole with the **left mouse button** and dislocate it, still pressing the left mouse button. It is also possible to **delete** boreholes. To do so, select the centre of the borehole with the **right mouse button** and remove the borehole, still pressing the right mouse button. Thereby, the corresponding borehole disappears. Immediately, all other boreholes are newly numerated.

Clicking on the button **S3**, 3 concentric circles around the boreholes appear, whereof the colors give a hint at the g-value of the field of boreholes: Red indicates a high g-value and blue stands for a low value. The color scale is not an absolute scale but a relative: The highest value in the field of boreholes always has the same red while the lowest value has the same blue. The colors give a hint at the relative distribution of the temperature in the ground around the borehole.

It is possible to zoom in (button **S7**) and to zoom out (button **S6**) of the borehole field if the field of boreholes is bigger than the displayed range. Thereby, the left, upper corner always keeps the coordinate 0/0. The button “delete” (**S5**) deletes **all** boreholes.

By pressing the button **S2** the whole sheet can be copied into the clipboard and thus be used for reporting in other programs as Word. The sheet “Field of boreholes” can be quit with the button **S1**, whereby all input data will be saved (number of boreholes, coordinates of the boreholes, distances of the boreholes, g-function). The values of the g-function are transferred to the fields 1.15 to 1.19 of the sheet “Boreholes” and can be checked there.

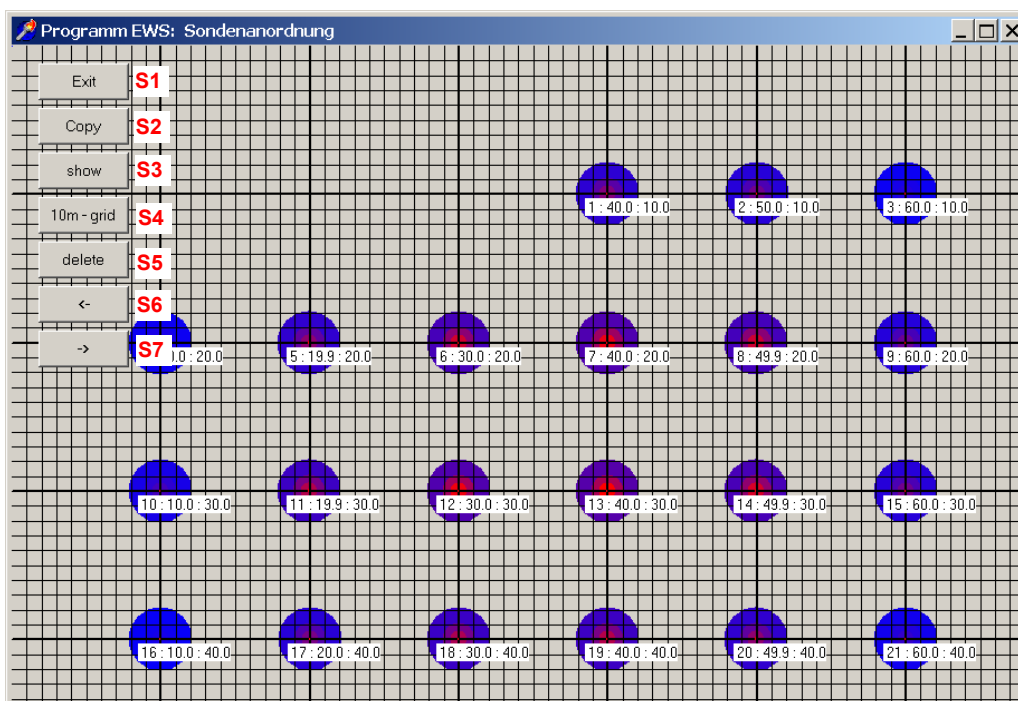

Fig. 3.13: The sheet “Field of boreholes” with 21 boreholes. The “blue” boreholes give a higher yield, the “red” boreholes give a lower yield.

3.3.2 Inserting a background-map in 4 easy steps:

In the full version of the program there exists the possibility to insert a background-map. This map can be scaled. The picture of the map has to be in the BMP-format and must be stored in the clipboard first (e.g. by getting a „printscreen“ of one of the existing GIS-browsers) and can then be pasted into the sheet „field of boreholes“ by pressing on the **middle mouse button (mouse wheel)**. In the next step the grid must be scaled to fit to the inserted map. To do so, with the button **S8** („scale“) a well known distance can be inserted in field **S9** and defined on the map by marking the starting point Mp1 and the ending point Mp2 with the left mouse button. With the buttons **S6** and **S7** the map and the grid finally can be set to the favored size on the screen. Now we are ready to define the positions of the borehole as described in 3.3.1. As soon as the first borehole is set, the background map can not be changed any more. In the following pictures the 4 steps to insert a background map are shown in detail:

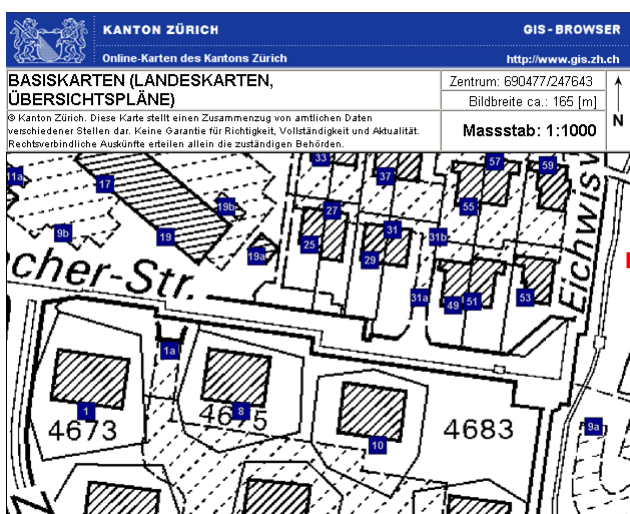

Fig. 3.14: **1. step:** Store an appropriate map in the clipboard (e.g. by getting a printscreen of one of the existing GIS-browsers as www.gis.zh.ch)

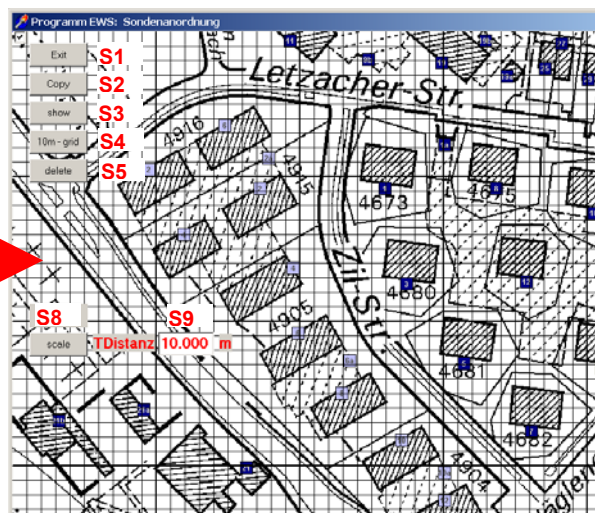

Fig. 3.15: **2. step:** By pressing the middle mouse button / mouse wheel into the sheet "field of boreholes" the clipboard is pasted on the screen.

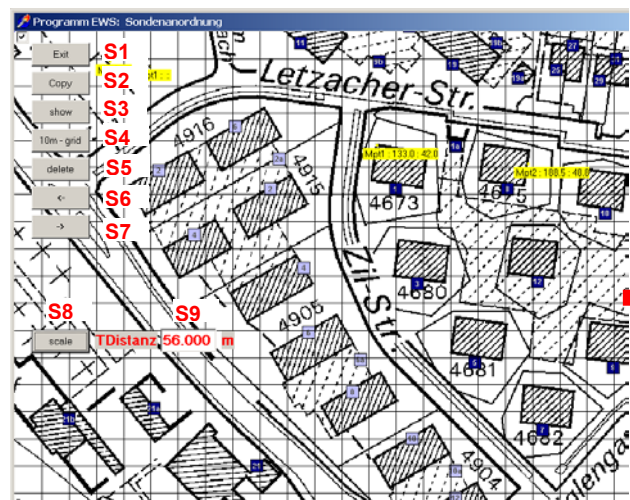

Fig. 3.16: **3. step,** scaling the map: Choose 2 well known points on the map, define the distance of these 2 points (field S9) and mark the 2 points by pressing the left mouse button on this points. Finalize this step by just clicking into the map.

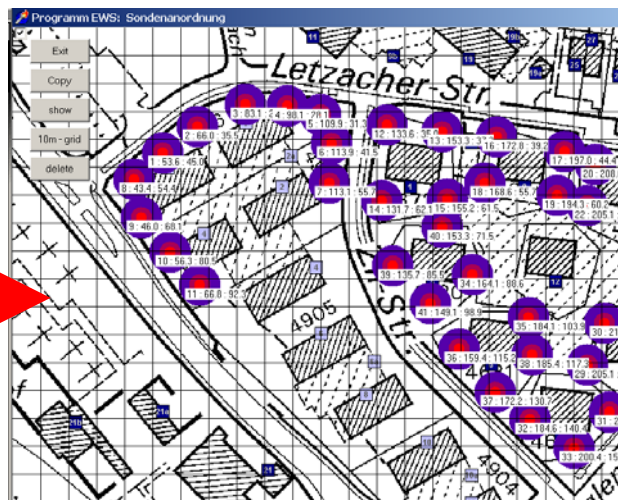

Fig. 3.17: **4. step:** With the buttons S6 and S7 the map and the grid finally can be set to the favored size on the screen. Now insert the borehole positions as described in 3.3.1. **Note:** As soon as the first borehole is set, the map can not be changed any more!

3.3.3 Optimization of borehole fields

The procedure of the optimization of a field of boreholes shall be illustrated on a example with 5 x 10 boreholes. The blue colored boreholes have the highest yield. Boreholes with lower yields (they are located in the centre of the field where the heat hardly flows to) are purple at the borders and dark red in the centre. The **button 1.12** shows a graph of the g-function which makes the difference easily visible: The g-function can be reduced by 8% with the relocation of the 4 central boreholes. This means that on a long term basis the borehole temperature increases 8% if the same charge of the boreholes is simulated.

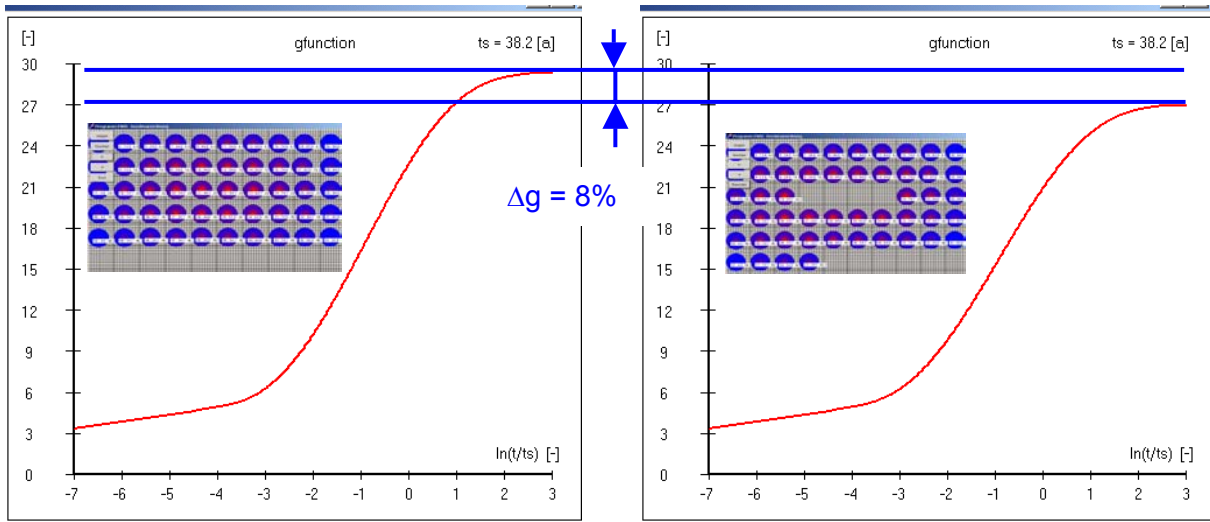

Fig. 3.18: The comparison of 2 borehole fields with 50 borehole of 100m depth and 10m distance.

3.4 Calculation of a single borehole in a field of boreholes

There exists the possibility to calculate the g-function of a single borehole in a field of boreholes (see Fig. 3.19) if the borehole field was defined according to the description in chapter 3.3.

ln(t/ts) = -2	6.727	1.15
ln(t/ts) = 0	9.292	1.16
ln(t/ts) = +2	10.660	1.17
ln(t/ts) = +3	10.800	1.18
single borehole Nr? (0=all)	2	1.19

Fig. 3.19: The calculation of a single borehole in a field of boreholes.

3.5 The sheet “Fluid”

The data about the fluid and the filling can be entered in the sheet “Fluid”.

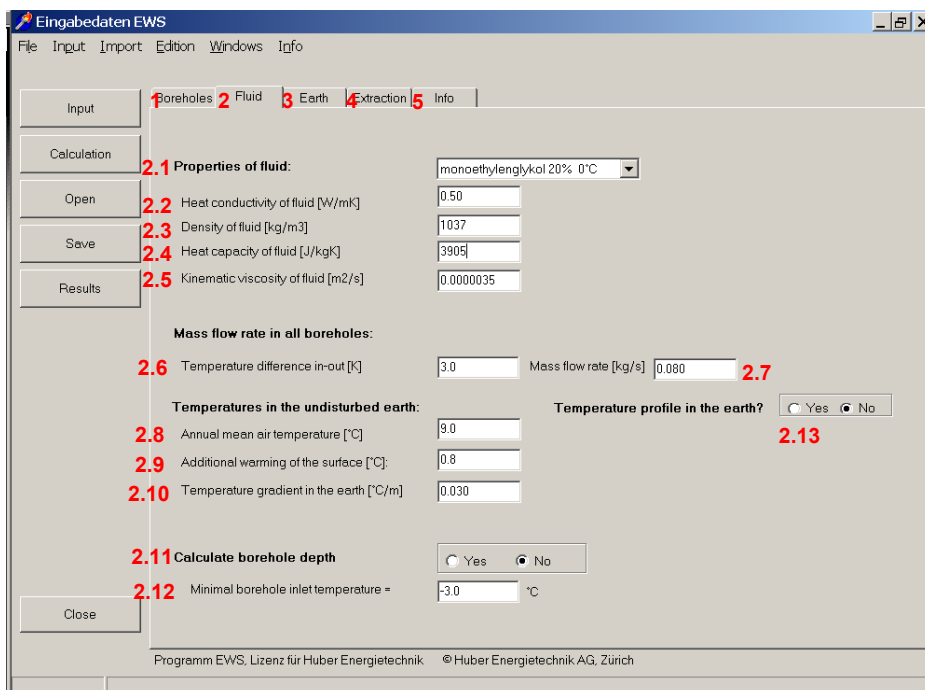

Fig. 3.20: The sheet “Fluid”.

field 2.1 By selecting one composition of the fluid in the pull-down **field 2.1** all corresponding data (the heat conductivity, the density, the specific heat capacity and the kinematic viscosity of the fluid) are entered automatically. If the used fluid is not listed in the pull-down field 2.1 there is the possibility to select “not defined” and to enter the values of **fields 2.2 to 2.5** manually.

fields 2.6/2.7 The required input in **field 2.7** is the designed mass flow rate (cumulated mass flow of all boreholes). If this mass flow rate is unknown, there exists the possibility to enter the temperature difference between the borehole inlet and the borehole outlet temperature in **field 2.6**. Immediately, the program adjusts the mass flow rate (**field 2.7**) using the eq.3.1 and the inputs of the heat extraction rate (**field 4.4**), the temperature difference (**field 2.6**) and the heat capacity of the fluid (**field 2.4**). It is important to know that the program does all calculation using the value of the mass flow rate (**field 2.7**). The value in field 2.7 can be changed anytime without causing an adjustment of other variables, while changes of the other variables (fields 2.4, 2.6, 4.4) result in an adjustment of the mass flow rate.

$$\dot{m} = \frac{\dot{Q}}{\Delta T \cdot c_p} \tag{eq. 3.1}$$

Hence, it is possible that the four variables are inconsistent and do not fulfill eq. 3.1 if the last of the four entries concerned **field 2.7**. In such a case the program neglects the entry in **field 2.6** and calculates with the value of the **field 2.7**. But be aware that if the heat extraction rate (**field 4.4**) is entered after the designed mass flow rate (**field 2.7**), the program adjusts the value of the **field 2.7** and calculates no longer with the wanted mass flow rate. Thus, check the mass flow rate after the three other variables are entered and correct the value if necessary. Furthermore, it is recommended always to enter the designed temperature difference (**field 2.6**).

3.5.1 The temperatures in the undisturbed earth

There exist 2 methods to insert the data for the undisturbed temperature in the earth (starting condition for the simulation):

1. Entering the annual mean air temperature (**field 2.8**), the additional warming of the surface (**field 2.9**) and the temperature gradient ΔT_{Grad} in the earth (**field 2.10**). With the mean air temperature, the dependency of the altitude must be taken into account (reduction of some 0.47K at every 100m higher altitude). The mean air temperature and the additional warming of the surface are simply added in the program. For the temperature gradient ΔT_{Grad} , the geothermal heat flux \dot{q}_{geo} and the thermal conductivity of the earth λ_{Earth} exists the following correlation:

$$\dot{q}_{geo} = \lambda_{Earth} \cdot \Delta T_{Grad} \quad [W / m^2] \quad \text{eq. 3.2}$$

2. Directly entering the temperature profile in the undisturbed ground (**fields 2.15**). The surface temperature will in this case be extrapolated linearly out of the first two inserted values.

To change from method 1 to method 2, **field 2.13** must be set to „Yes“. In this case, the input fields 2.8 – 2.10 will disappear and the **fields 2.15** and **button 2.14** („Graph“) will appear instead. With these, the temperature profile in the earth can be defined.

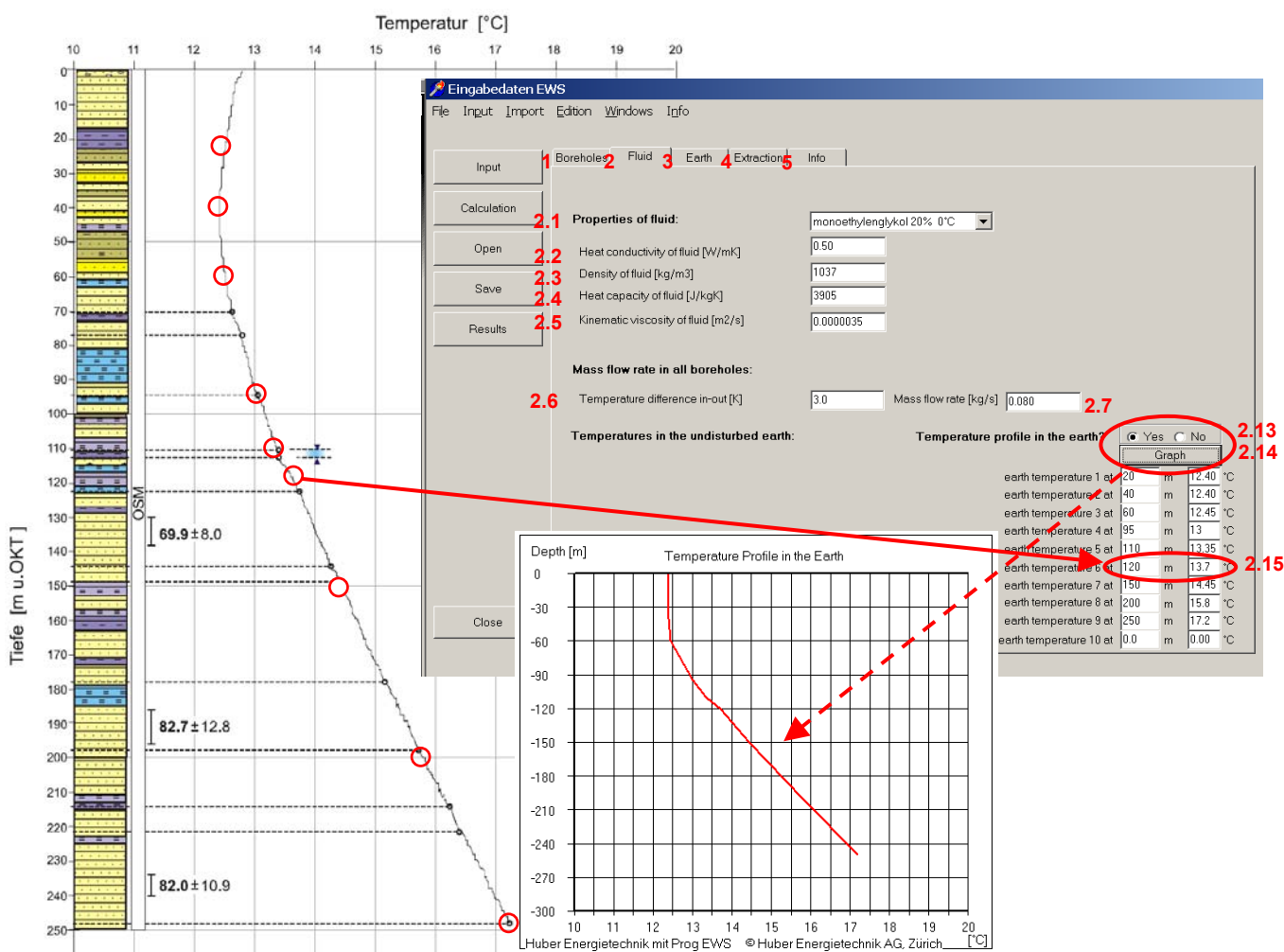

Fig. 3.21: Input of the undisturbed temperature profile in the earth out of a measurement. (Example from a measurement of Dr. U. Schärli / E. Rohner [16]).

3.5.2 Automatically calculated borehole length

The program EWS is able to calculate automatically the necessary borehole length according to the norm SIA 384/6 [18]. To do so, the simulation period in field 4.8 or field 10.15 has to be set to **50 year** and the minimal borehole inlet temperature in **field 2.12** and the temperature difference in **field 2.6** have to be set according to the norm SIA 384/6 (minimal mean temperature of the brine must add up to -1.5°C , e.g. minimal borehole inlet temperature in **field 2.12** set to -3.0°C and the temperature difference in **field 2.6** set to 3.0 K). To start the calculation, the **field 2.11** must be set to “Yes” and the calculation can be started with the button “Calculation”. The program EWS then calculates the minimal borehole length and the resulted length can be read in **field 1.4**.

3.6 The sheet “Info”

This sheet helps to specify the project, to describe the variant and to name the author as well as to add some remarks.

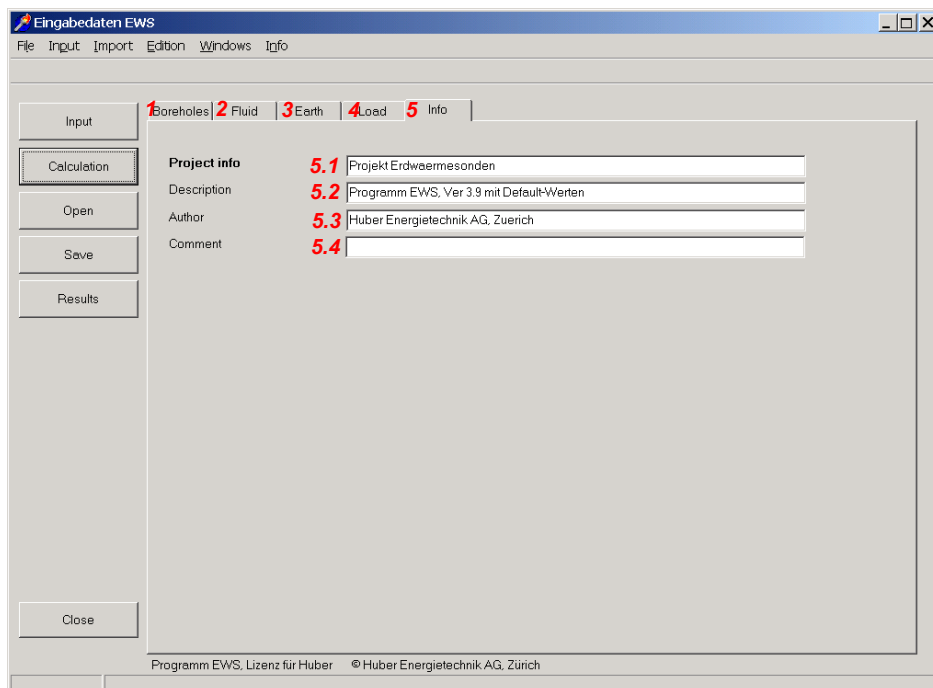

Fig. 3.22: The sheet “Info”.

3.7 The sheet “Earth”

On the sheet “Earth” the thermal properties of the ground and the filling material can be defined. Furthermore, the number of horizontal layers in the earth are defined on this sheet (field 3.1, maximal 10 layers). The thermal borehole resistances R_a and R_b are entered in the fields 3.4 and 3.5. If the borehole resistances are unknown, they can be calculated from the borehole geometry and the properties of the filling material (see chapter 5.6).

3.7.1 Basic Inputs

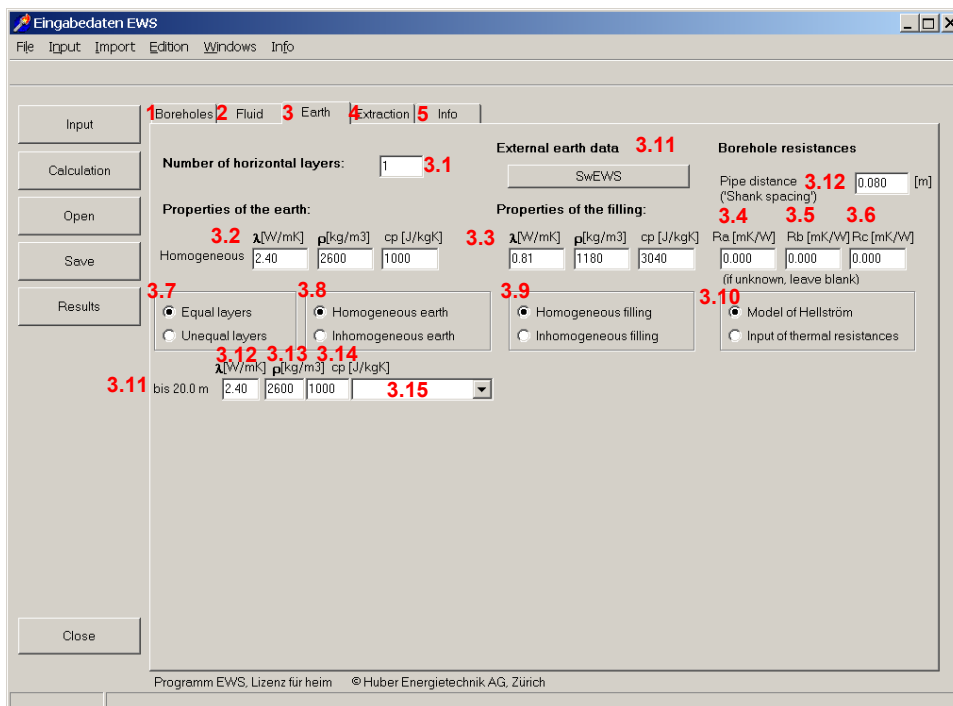

Fig. 3.23: The sheet “Earth” (with a single, horizontal layer).

3.1 First, the user defines the number of horizontal layers in the earth. The calculations are executed using equal layers (see below). Calculations with only one horizontal layer (and averaged properties) save computing time but provide less accurate results (because of the coarse calculation grid). Nevertheless, this is often precise enough for boreholes up to a depth of 100 m or for a first, rough dimensioning.

Due to numerical reasons the program EWS calculates internally with a uniform calculation grid in the vertical direction of the boreholes, even if in field 3.7 unequal layers are selected (which is possible only in the full version of the program). The program EWS then averages internally the physical properties of the earth for every vertical calculation layer. The averaging is done prior to every calculation run. Thus, even in the case of a variation in the borehole depths, there is no need for adjustments of the earth’s definition (field 3.11 – 3.15).

3.2 “Properties of the earth”: The averaged physical properties of the earth (heat conductivity λ [W/mK], density ρ [kg/m³] and specific heat capacity c_p [J/kgK]) can be entered in the field 3.2 if in the field 3.7 “equal layers” and in the field 3.8 “homogeneous earth” are selected. In this case, the values are transferred automatically to the fields 3.12 – 3.14. The program EWS always computes internally with the values from the fields 3.12 – 3.14. If the user adjusts the values in

the **fields 3.12 – 3.14** in a later phase it might happen that the inputs (**field 3.2** and **fields 3.12 – 3.14**) are no longer consistent. In such a case, the values in the **field 3.2** are ignored and they are adjusted in the next calculation run.

Furthermore, the program EWS calculates for each run the arithmetic mean of the “properties of the earth” for the whole borehole depth. The results are showed after the run in **field 3.2**.

Hence, on the one hand, **field 3.2** is an input assistance and on the other hand it is an output field for the arithmetic mean of the physical earth properties for the whole borehole depth.

3.3 In **field 3.3** the “properties of the filling” (heat conductivity λ [W/mK], density ρ [kg/m³] and specific heat capacity c_p [J/kgK]) can be entered if in **field 3.9** “homogenous filling” is selected (what usually is the case) or if the calculations are done with a single horizontal layer. The “properties of the filling” are used for the calculation of the thermal borehole resistances R_a and R_b (see chapter 5.6).

3.4 – 3.6 The borehole resistances R_a , R_b , R_c can be found in the **fields 3.4 – 3.6**. The definition of the resistances R_a , R_b , R_c are given in chapter 5.6.

The default setting of the program EWS calculates the borehole resistances by the equations given by Hellström (see chapter 5.6, option **field 3.10**). In this case the inputs in the **fields 3.4 – 3.6** are ignored (**there is no need for an input**). The borehole resistances are calculated prior to each run using the equation by Hellström and considering the properties of the filling material (**field 3.3**), the mass flow rate (**field 2.7**) and the distance between the pipes in the borehole (**field 3.12**). The calculated values for R_a , R_b and R_c are showed in the **fields 3.4 – 3.6** after each run.

The internal resistance R_a (**field 3.4**) and the resistance of the borehole R_b (**field 3.5**) can be entered if in the **field 3.10** “Input of thermal resistance” is selected. **In this case R_c (field 3.6) must be set to zero.** Otherwise the value for R_c (field 3.6) is used to calculate R_b (eq. 5.30) and the input of R_b will be replaced by this new R_b . In case of any adjustment of the mass flow rate, R_a and R_b (but not R_c) are set to zero and recalculated with the new mass flow rate (eq. 5.30), since R_a and R_b depend on the flow velocity of the fluid (by the heat transfer rate α). The detailed calculation and all possible options are given in [5].

3.10 / 3.12 There is no need to enter the values of the thermal resistances in the **field 3.4 – 3.6** if “Model of Hellström” in **field 3.10** is selected. In this case, the program EWS calculates the thermal resistances in the next run. But the distance between the up-going and down-going pipe (shank spacing, **field 3.12**) must be entered (see chapter 3.2.2) using the “Model of Hellström”. Generally, the default value for the pipe distance can be used. The default value for the pipe distance is calculated from the borehole diameter and the pipe diameter under the assumption that the pipes are placed at the borehole’s wall. However, a later adjustment of the borehole diameter does not fit automatically the pipe distance.

3.11 With **button 3.11** earth data can be imported from the program SwEWS [11].

Caution: The number of horizontal layers must always be entered before property data from a SwEWS are imported.

3.7.2 Input of multiple horizontal layers

The earth is divided into multiple horizontal layers by entering the corresponding number (>1) in **field 3.1** (see Fig. 3.26). The maximal number of layers which can be defined is 10. The layers are equally spaced if “equal” is selected in **field 3.7**. The option “unequal” in field 3.7 must be selected to enter layers with variable depths (**available only in the full version**). The selected number of layers also corresponds to the number of layers in the numerical calculation but these layers are always equally spaced over the borehole depth (see chapter 3.7.1). The depth of the deepest geological layer must always be \geq the borehole depth.

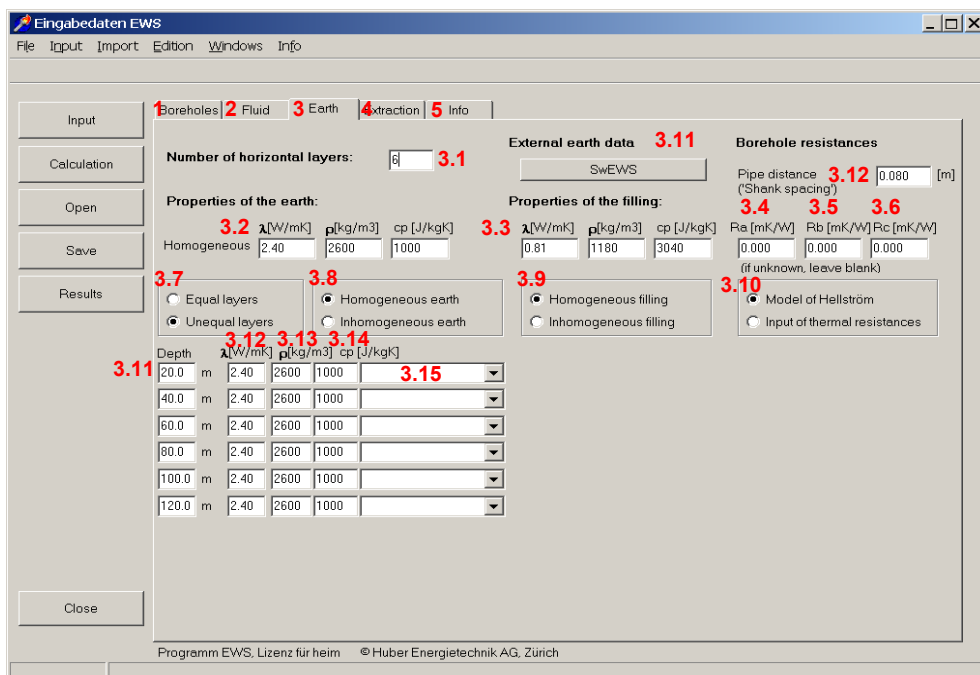

Fig. 3.24: The sheet „Earth“ with 6 horizontal layers of variable thickness.

Caution: The depth does not indicate the thickness of the corresponding layer but the distance from the deepest point of the layer to the surface of the earth.

After defining the number of horizontal layers, data about their properties can be entered into the suitable fields. It is possible to define layers which are deeper than the borehole itself. These layers are neglected as long as the borehole does not reach them. Therefore, it is recommended to enter the entire data of the known geology. This allows a later variation of the borehole depth without a need for adjustment in geology.

A horizontal variation of the filling material can be entered by selecting “inhomogeneous filling” in **field 3.9**. This option is only available if the layers are equally spaced what implies the selection of “equal layers” in **field 3.7**. Similar to the division of the earth, it appears a field with additional lines that can be used to enter the properties of the filling material (**field 3.16**) as well as of the borehole resistances (**field 3.17**) (see Fig. 3.25). The default values are taken from the **field 3.3** and **3.4 – 3.6**.

- 3.16 The physical properties of the filling material can be entered directly into these cells.
- 3.17 The procedure to set the values of the borehole resistances R_a , R_b and R_c is analog to the one for the fields 3.4 – 3.6 in chapter 3.7.1.
- 3.3 – 3.6 The arithmetic averages of field 3.16 and 3.17 are shown after each run in the fields 3.3 – 3.6.

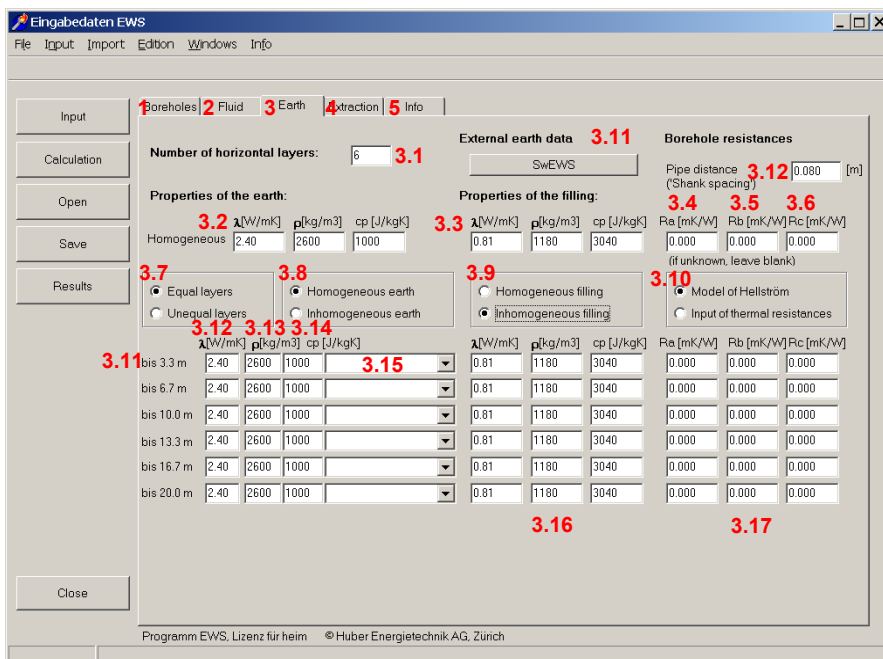

Fig. 3.25: The sheet „Earth“ with a inhomogeneous filling of the borehole.

3.7.3 Physical properties of the earth

For each horizontal layer appears a line to enter its properties. Either the properties can be entered directly into the cells or an earth type can be selected from the pull-down menu. The earth types in the pull-down menu are linked with the appropriate physical properties (see Fig. 3.26).

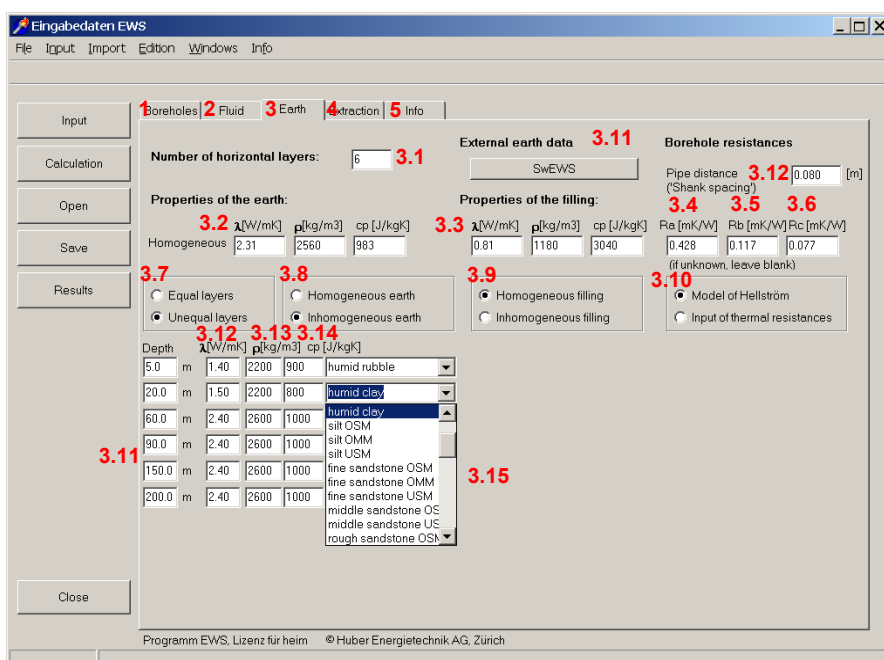

Fig. 3.26: The sheet „Earth“ offers a selection of rocks in the pull-down menu.

The program EWS also offers the option to enlarge the library in the pull-down menu by adding new earth types with their own names and physical properties (see Fig. 3.27). This can easily be done by entering manually the data into the suitable cells. After a run the new defined earth types appear at the bottom of the pull-down menu.

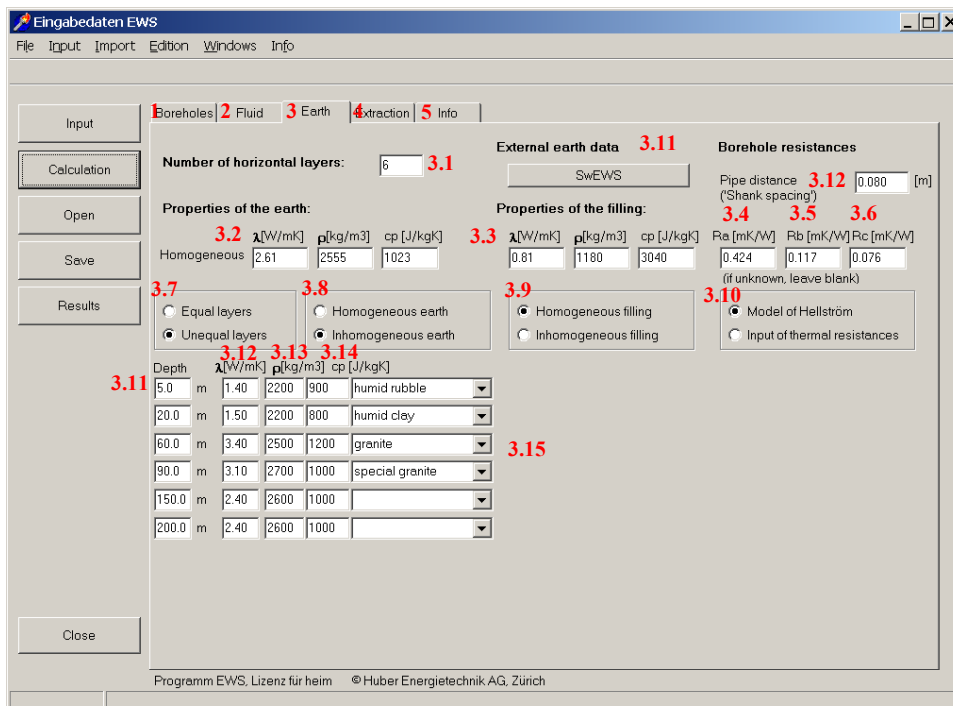

Fig. 3.27: The sheet „Earth“, nomenclature of rocks and the input of their property data.

3.7.4 Creation of a user defined geological library

The program EWS offers the possibility to create a user defined, geological library with a maximum of 30 different earth types and their physical properties. Once the library is established, it is loaded automatically when the program is started and the entries appear in the pull-down menu (field 3.15).

The first step to establish a library is to create a table in excel with the name of the earth types and the appropriate physical properties (see Fig. 3.28). The names and the properties must be entered below the header (row 2 –31). The names must be entered in the first column, the λ -values in the second column, the ρ -values in the third column and the specific heat capacity in the forth column. There are two different types of limestone (limestone region Baden and limestone region Jura) defined in the example given below (see Fig. 3.28). The table must be saved as a text file (*.txt) with the name “Geologie.txt” in the same folder as the program EWS. In a next step it must be renamed to “Geologie.ews”. Thereafter, the created library is available in the pull-down menu (see Fig. 3.29).

Caution: The program EWS can only deal with decimal points (no decimal commas). Entries with decimal commas cause an error.

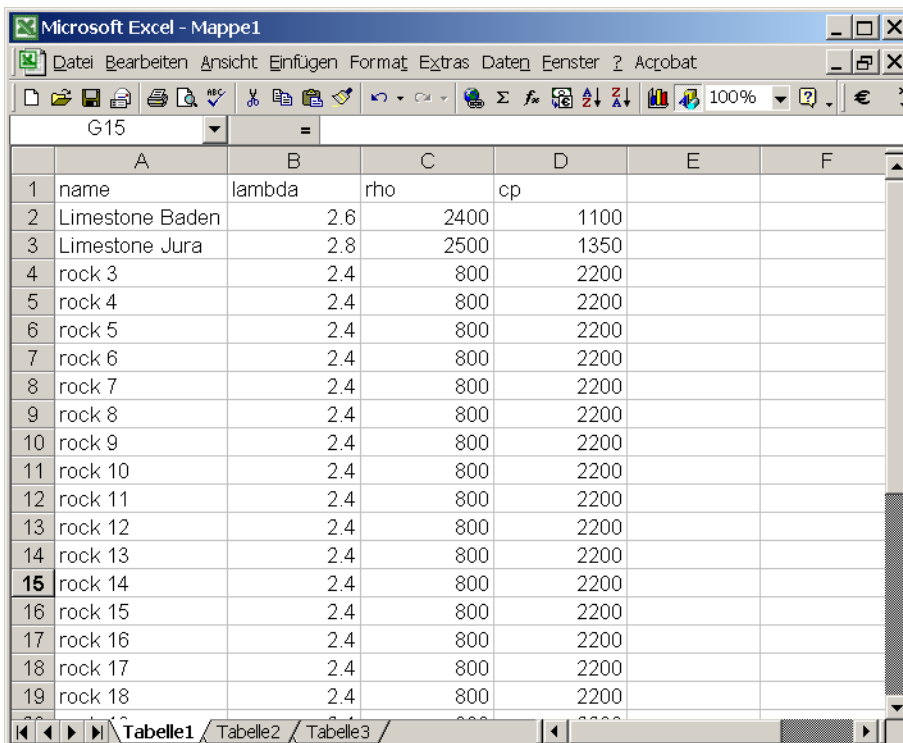

	A	B	C	D	E	F
	name	lambda	rho	cp		
1						
2	Limestone Baden	2.6	2400	1100		
3	Limestone Jura	2.8	2500	1350		
4	rock 3	2.4	800	2200		
5	rock 4	2.4	800	2200		
6	rock 5	2.4	800	2200		
7	rock 6	2.4	800	2200		
8	rock 7	2.4	800	2200		
9	rock 8	2.4	800	2200		
10	rock 9	2.4	800	2200		
11	rock 10	2.4	800	2200		
12	rock 11	2.4	800	2200		
13	rock 12	2.4	800	2200		
14	rock 13	2.4	800	2200		
15	rock 14	2.4	800	2200		
16	rock 15	2.4	800	2200		
17	rock 16	2.4	800	2200		
18	rock 17	2.4	800	2200		
19	rock 18	2.4	800	2200		

Fig. 3.28: Definition of the user-defined, geological library in the excel sheet "Geologie.ews"

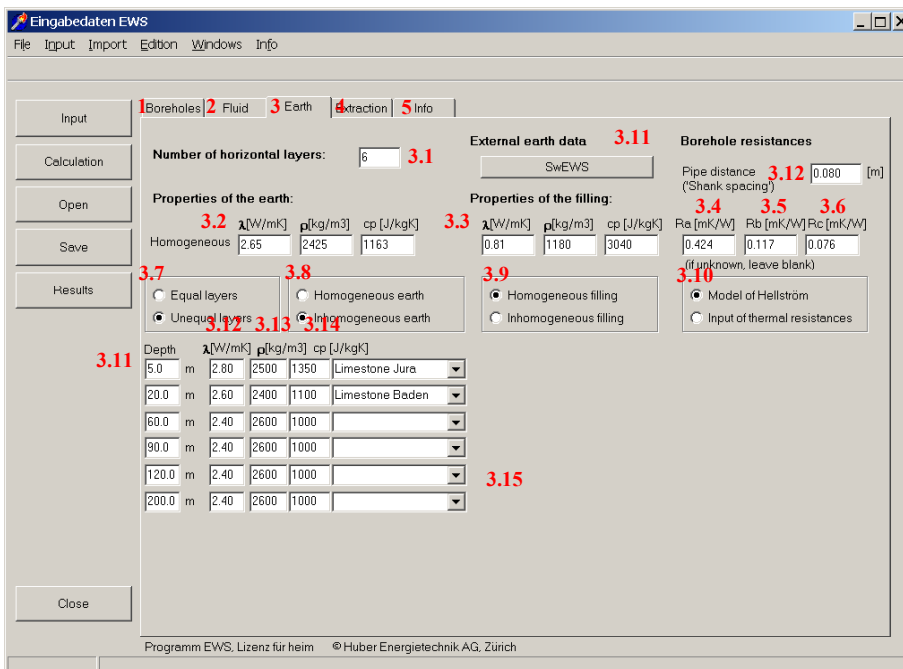

Eingabedaten EWS

File Input Import Edition Windows Info

Input | 1 Boreholes | 2 Fluid | 3 Earth | 4 Extraction | 5 Info

Calculation

Open

Save

Results

Close

Number of horizontal layers: 6 **3.1**

External earth data **3.11** SwEWS

Borehole resistances

Pipe distance **3.12** 0.080 [m] ("Shank spacing")

Properties of the earth:

Homogeneous **3.2** λ [W/mK] ρ [kg/m³] cp [J/kgK] **3.3**

2.65 2425 1163

Properties of the filling:

Homogeneous **3.4** λ [W/mK] ρ [kg/m³] cp [J/kgK] **3.5** **3.6**

0.81 1180 3040

Re [mK/W] Rb [mK/W] Rc [mK/W]

0.424 0.117 0.076

(if unknown, leave blank)

3.7 **3.8** **3.9** **3.10**

Equal layers Homogeneous earth

Unequal layers Inhomogeneous earth

Homogeneous filling Inhomogeneous filling

Model of Hellström Input of thermal resistances

Depth **3.11** λ [W/mK] ρ [kg/m³] cp [J/kgK] **3.15**

5.0 m	2.80	2500	1350	Limestone Jura
20.0 m	2.60	2400	1100	Limestone Baden
60.0 m	2.40	2600	1000	
90.0 m	2.40	2600	1000	
120.0 m	2.40	2600	1000	
200.0 m	2.40	2600	1000	

Programm EWS. Lizenz für heim © Huber Energietechnik AG, Zürich

Fig. 3.29: The sheet „Earth“ with the properties from the user-defined library "Geologie.ews"

3.8 The sheet “Extraction”

The load profile of the boreholes are entered in sheet “Extraction” (see. Fig. 3.30).

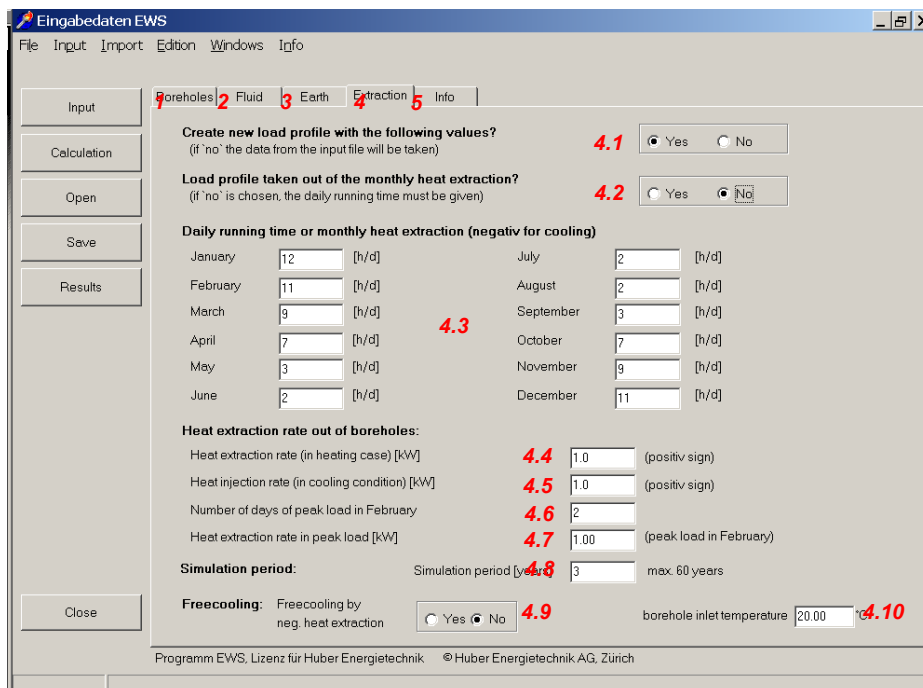

Fig. 3.30: The sheet “Extraction” with the input of the daily running time of the heat pump.

- 4.1 If the question “create new load profile with the following values?” is answered with “yes”, a load profile with the input data from this sheet is created. If the answer is “no”, the program uses the hourly input data from an external input file.
- 4.2 There are two option to create a load profile: The input of a daily running time of the heat pump or the input of the monthly heat extraction.
- 4.3 The field 4.3 requires a daily running time (for each month). If “no” is selected in the field 4.2. a minus must be added to the running time in the months in which the boreholes are used for cooling (what implies that heat is transferred to the borehole).
- 4.11 If “yes” is selected in the field 4.2, the field 4.11 requires a monthly heat extraction as an input (see Fig. 3.31). The cooling load must be written with a minus in this option, too.
- 4.4 The heat extraction rate in the heating case must be noted with a positive sign. If the heat extraction rate is changed, the mass flow rate in field 2.7 (the sheet ”fluid”) is adjusted automatically (see description 2.6/2.7).
- 4.5 The heat injection rate in cooling condition must be noted with a positive sign, too.

4.6/4.7 There is an option to simulate the peak load in the heating case by calculating a non-stop heating period. The duration of this period is defined with the input in field 4.6. The period always is simulated at the end of February which is the coolest period of the year. The field 4.7 defines the heat extraction rate during this period (which is normally equal the heat extraction rate in field 4.4).

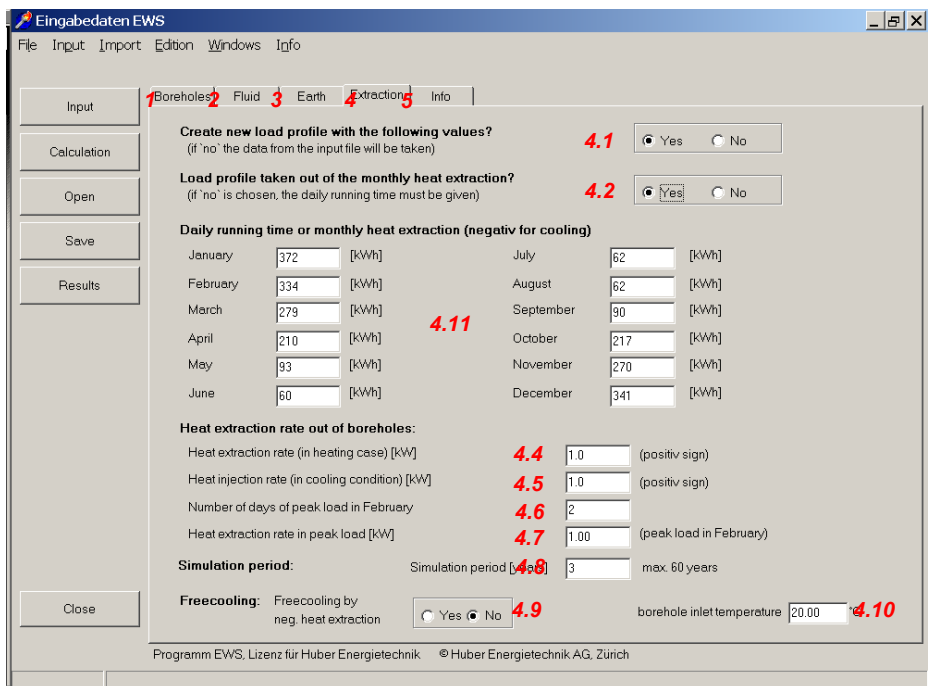

Fig. 3.31: The sheet "Extraction" with the input of the monthly heat extraction

3.9 The sheet "Load"

The full version of the program EWS offers alternatively to the direct input of the heat extraction in the sheet "Extraction" (chapter 3.8) another possibility to enter the borehole load. Thereto, the sheet "Load" can be opened under the pull-down "Input" (see Fig. 3.32). It appears the sheet "Load" and the sheet "Extraction" gets hidden (see Fig. 3.33). The sheet "Load" needs as an input the monthly heating energy to calculate the heat extraction of the boreholes using the COP of a heat pump. The sheet "Load" can not be combined with the sheet "Heat pump".

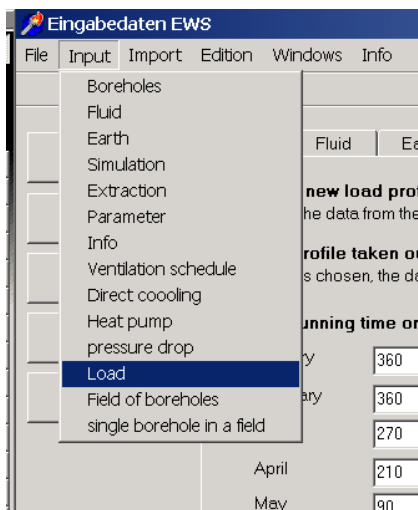

Fig. 3.32: The selection of the sheet "Load".

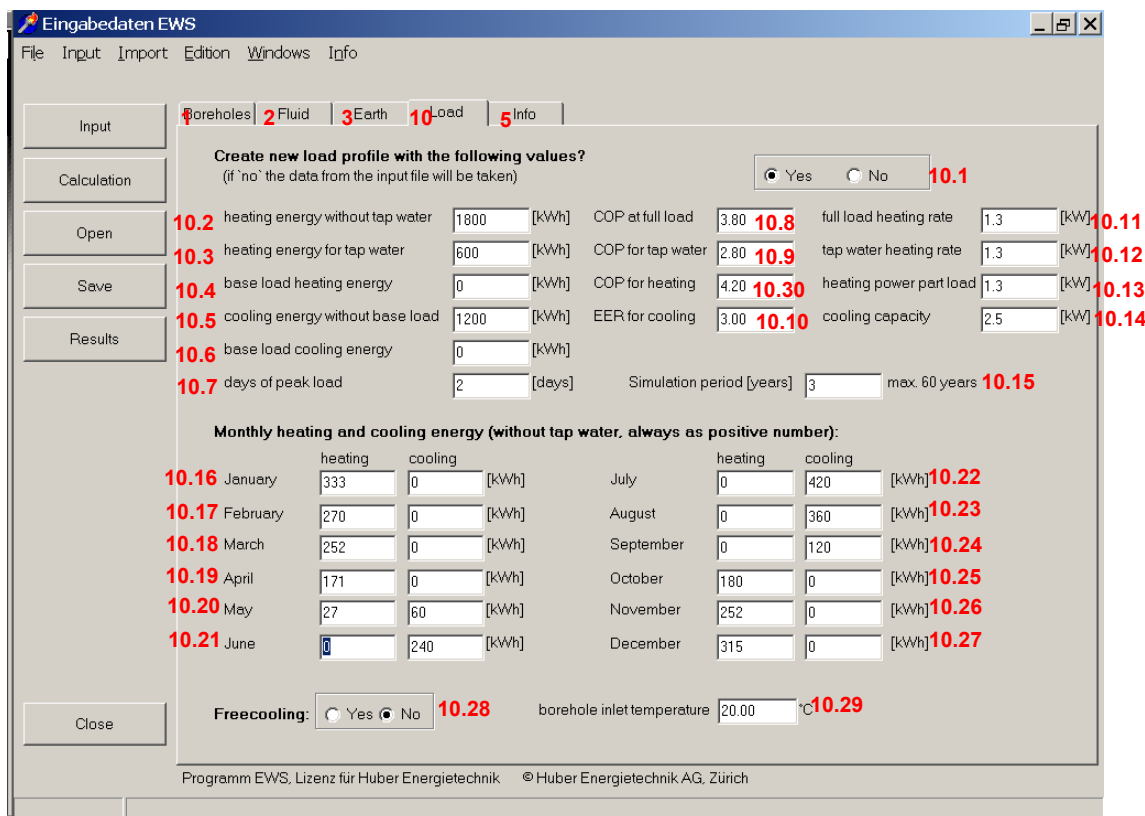

Fig. 3.33: The sheet "Load" with the input of the heating energy.

In the sheet “Load” the monthly heating and cooling energy demand is defined. In contrast to the sheet “Extraction” the heating and the cooling energy in the sheet “Load” are in kWh and with a positive sign. The program EWS calculates a load profile for an intermittent mode under consideration of the COP and the heating and cooling power of the heat pump. Excluded of this intermittent is the base load (field 10.4 and field 10.6) which influences the load profile independently of the installed heating or cooling power. In the heating case, the borehole heat extraction rate is reduced by the compressor power which can be calculated with the COP. The heat injection rate in cooling condition is increased by the compressor power and is calculated with the EER (COP-1).

The mass flow rate (field 2.7) is adjusted to the heat extraction rate considering the eq. 3.1 and the temperature difference (field 2.7) (this means a variable mass flow rate).

- 10.1** If the question “Create a new load file with the following values?” is answered with “yes”, the load profile is calculated with the values from the fields 10.2 – 10.27. If the answer is “no”, the load profile is taken from the input file and the inputs 10.2 – 10.29 are ignored.
- 10.7** Duration of the peak load (non-stop operation) at the end of February.
- 10.8** COP of the heat pump during the full load (10.11).
- 10.10** Input of the EER of the cooling machine (= cooling-COP_c, i.e. the ratio of the cooling energy and the consumed electric power). There should be entered a high value (e.g. 999) if the freecooling option in field 10.28 is selected.
- 10.11** The heat extraction rate during the maximal load, end of February. The duration is defined in the field 10.7.
- 10.13** The heat extraction rate during a part load. This heat extraction rate is rounded to be equal to the total heating energy of 10.16 – 10.27.
- 10.15** The duration of the simulation (maximal 100 years). Always the last year of the period is evaluated.
- 10.28** The cooling temperature of the borehole inlet is limited if the freecooling option is selected. The coverage of the cooling demand can be seen on the sheet “Results”
- 10.29** The borehole inlet temperature in the freecooling case. **Attention:** The borehole inlet temperature mostly is lower than the return temperature of the cooling loop (because of the heat exchanger).
- 10.30** Mean COP of the heat pump in the heating period (at part load 10.13).

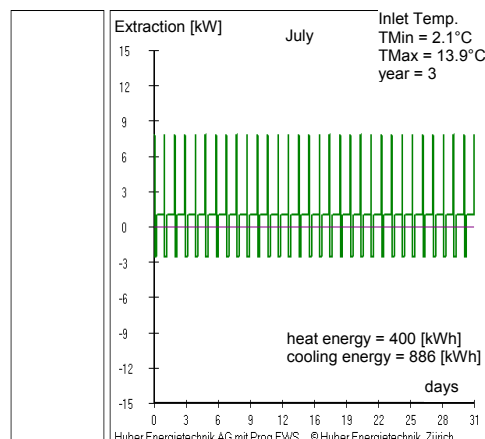

Fig. 3.34: The extraction rate profile of an intermittent mode, created with the sheet “Load”.

3.10 The sheet “Simulation”

3.10.1 The sheet “Simulation”

Various special calculations can be done with the sheet “Simulation”. Open the sheet “Simulation” with the pull-down menu “Windows” from the menu bar and select “Simulation” (see Fig. 3.35).

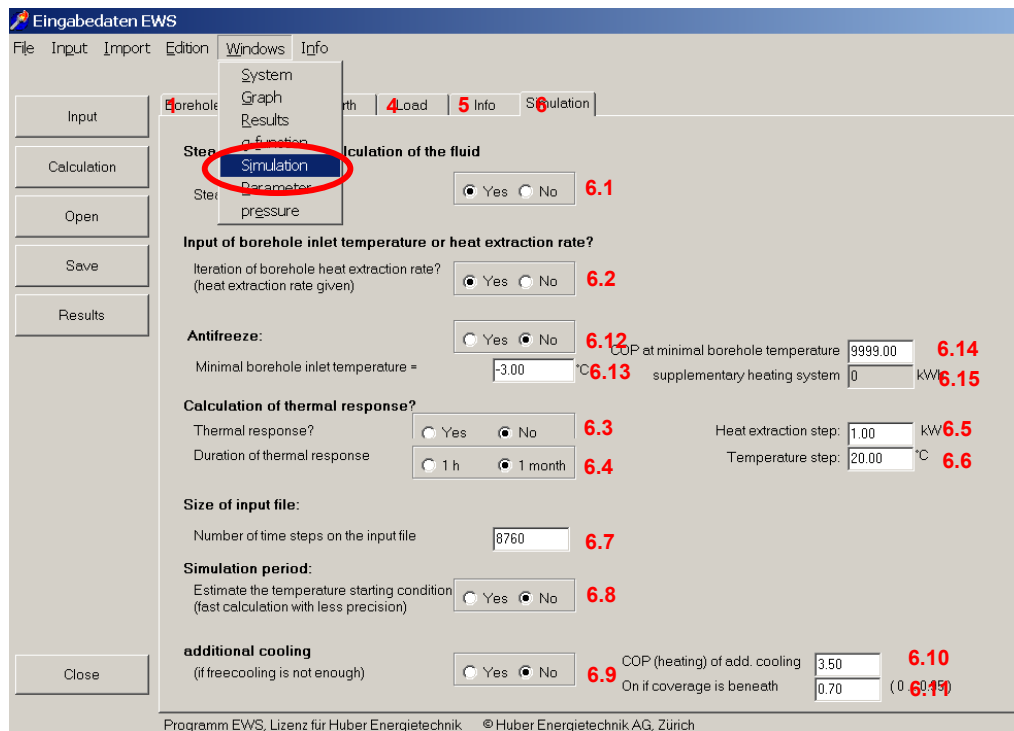

Fig. 3.35: The opening of the sheet “Simulation”.

The following, special calculations can be executed with the sheet “Simulation”:

- The unsteady calculation of the fluid (field 6.1). The default setting of the program does steady state calculations of the fluid like it can be found in ref. [5] and [6].
- The input of the extraction rate, e.g. forced by the heat pump or the borehole inlet temperature (e.g. direct cooling). For these cases, the field 6.2 must be selected (“yes”). The default setting calculates the needed outlet and inlet temperature of the borehole fluid to generate the wanted extraction rate of the heat pump. More detailed information can be found in chapter 4.1.
- The calculation of the thermal response (response test, field 6.3). More details can be found in chapter 5.3.3.
- The size of the input file (field 6.7). The default setting calculates 8760 steps of 60 minutes. But it is possible to calculate a time period of less than one year and hence, to calculate with a smaller input files. **Note:** There are max. 8760 time steps possible.
- The estimation of the start temperature (field 6.8). This option results in a shorter calculation time for long simulation periods (>10 years). But the results are less precise and they should only be use for rough estimations.

3.10.2 Input of the heat extraction rate and the borehole inlet temperature

The borehole inlet temperature in **field 6.6** or in **field 4.10** is taken as a base for the calculations of the possible heat extraction rate (i.e. the heat extraction rate is not determined by the heat pump) if in **field 6.2** “no” is selected.

3.10.3 The active, additional cooling if freecooling is not sufficient

If in the **field 6.9** “yes” is selected, there is an additional cooling machine installed which uses the boreholes as a back cooling. The cooling machine is activated if the freecooling covers less than a certain fraction of the total cooling demand (the fraction is defined in the **field 6.11**). In this case, the boreholes have to absorb the compressor power of the cooling machine which is calculated with the heating COP (=EER +1) of the cooling machine (**field 6.10**).

3.10.4 Antifreeze (minimal brine temperature) und bivalent heat pump systems

To ensure the anti-freeze protection and to take into account of bivalent heat pump systems, a minimal brine temperature can be set in **field 6.13**. To activate the anti-freeze protection, the **field 6.12** must be set to “Yes”. When now the brine temperature is falling below the minimal temperature in **field 6.13**, the heat pump stops to work and there is no heat extraction any more from the borehole. In order to be able to calculate the missing heat when the heat pump stops to work, the COP of the heat pump at the minimal brine temperature must be given in **field 6.14**. In **field 6.15** the missing heat production of the heat pump is added up after the calculation of the system.

3.10.5 The response test

Open the sheet “Simulation” (menu bar “Windows”) to check the thermal response test (see Fig. 3.35).

Select the thermal response on the sheet “Simulation” (**field 6.3**). This changes automatically various default values:

- It is only possible to calculate reasonable results for the unsteady borehole fluid. Therefore, **field 6.1** is set to “no”.
- The calculation of the thermal response must be done with the maximal number of ground layers. Thus, the number of horizontal layers in the earth is set to 10 (**field 3.1**).
- The time steps for the simulation of the fluid and of the earth are reduced. For this purpose the time step factor of the fluid (**field 7.5**, “security 1”) is changed from 4 to 40 and the one of the earth (**field 7.6**, “security 2”) from 2 to 20.
- The time step to calculate the boreholes is set to 1 minute if the duration of the thermal response is set to 1 h (**field 6.4**).
- The size of the input file for the thermal response (**field 6.7**) is adapted to the duration of the thermal response.

The classical case of the thermal response test extracts or adds the ground a constant heat rate. This rate must be entered in field 6.5. Thereby, it must be paid attention to the convention of the signs:

- positive sign: -> heat extraction from the earth
- negative sign: -> heat induction to the earth

The temperature step (field 6.6) is ignored in this type of response test.

Do not forget to enter or readjust the correct mass flow rate (field 2.7)!

Fig. 3.36 illustrates the first 60 minutes of the thermal response of a borehole (40mm double-U-pipe, depth: 150 m, mass flow rate: 0.7 kg/s of 33% monoethylenglykol, heat input of 10kW). The first temperature maximum after 6.5 minutes is clearly visible. This maximum is a consequence of the piston-effect of the fluid.

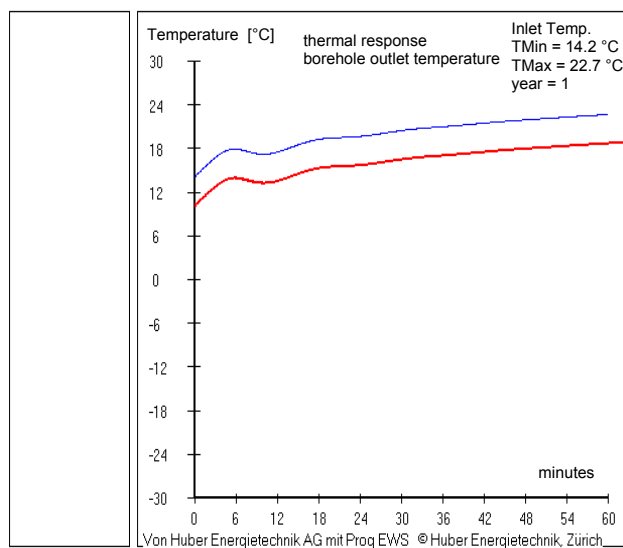

Fig. 3.36: The example of the thermal response of a borehole during the first hour.

There is another type of the thermal response test which is less frequently used. In this type the borehole inlet temperature is constant and the borehole outlet temperature and the borehole heat extraction rate is analyzed. For this type of response test field 6.2 (“Iteration of borehole heat extraction rate?”) must be set to “no” and the constant borehole inlet temperature must be entered in field 6.6. This type ignores the “heat extraction step” (field 6.5).

3.11 The sheet “Parameter”

Select the sheet “Parameter” from the pull-down menu “Windows” in the menu (see Fig. 3.37). The simulation grid, the simulation time steps and the stop criterion for the iteration can be defined in the sheet “Parameter”. The time step for the calculation of the thermal borehole resistance R_b can be defined in field 7.15. Field 7.15 is set to “no” in the default setting. In this case, R_b is calculated with the given design mass flow rate (field 2.7) at the beginning of a simulation and it remains constant for the rest of the simulation period. If field 7.15 is set to “yes”, R_b is recalculated in each time step (hourly). Thereby, the computing time increases, but the result can get more accurate.

Additionally, the design of the output file can be set on the sheet “Parameter”.

Normally, the user has not to fill in the sheet “Parameter”, since it can be calculated with the default values for most cases.

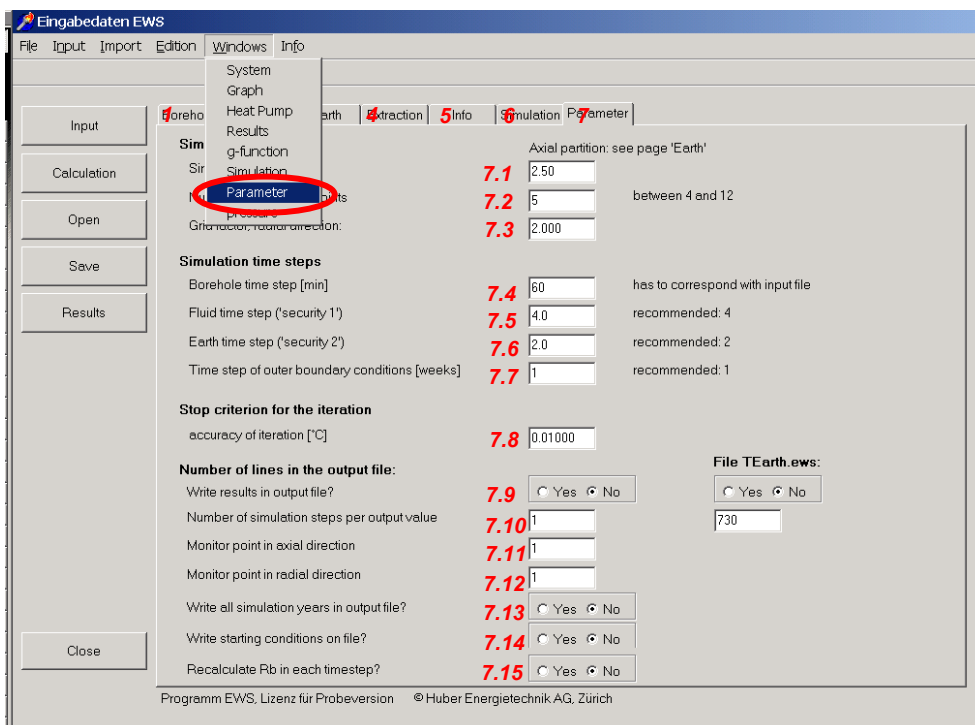

Fig. 3.37: The sheet “Parameter”.

In field 7.15 is defined whether the thermal borehole resistance R_b is recalculated for each calculation step. The borehole resistance R_b (thermal resistance between borehole and fluid) is basically a parameter which is influenced by geometrical factors of the borehole, by the properties of the filling material and by the pipes. Additionally, it includes the heat transfer coefficient α (from the piping wall to the fluid) which depends on the mass flow rate in the pipes. Since the program EWS offers the option to simulate a variable mass flow rate, the user gets two options: Either the heat transfer coefficient α (and thereby the thermal borehole resistance R_b) is recalculated for each calculation step or R_b is kept constant for the hole simulation. If the field 7.15 is left on the default setting (“no”), R_b is calculated at the beginning of the simulation on the basis of the design mass flow rate (field 2.7).

3.12 The sheet “Pressure”

To open the sheet “Pressure”, open the pull-down menu “Windows” from the menu bar and select the sheet “Pressure” or open the pull-down menu “Input” from the menu bar and select “Pressure drop” (see Fig. 3.39). This option is only available in the complete version of the program EWS.

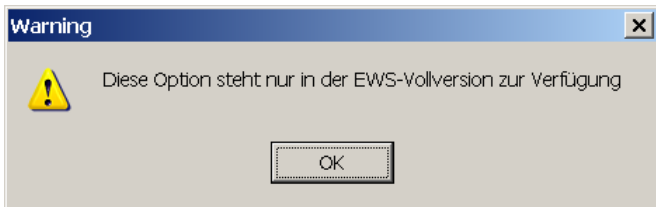

Fig. 3.38: Error message, if no full version of the EWS Program is available.

In the sheet “Pressure” it is possible to calculate the pressure drop in the borehole. Additionally the flow regime is calculated (laminar or a turbulent flow regime in the pipes). A more detailed description of the used model is given in reference [15].

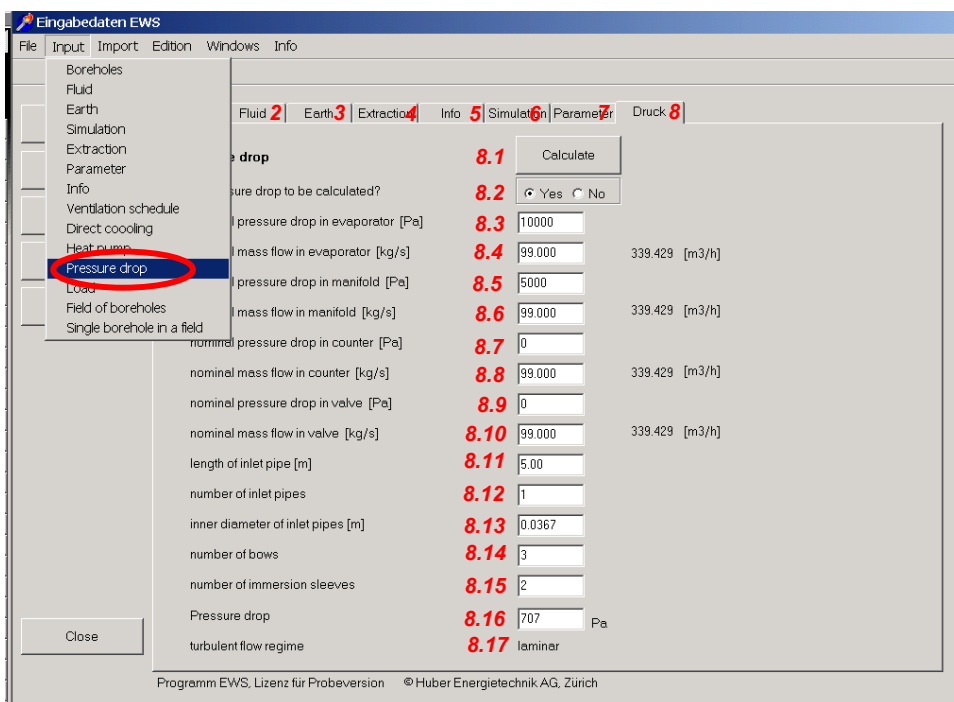

Fig. 3.39: The sheet “Pressure”.

- 8.1 After each change of the input data, the button “Calculate” must be clicked to calculate the new results.
- 8.2 If field 8.2 is set to “yes”, the pressure drop in the borehole pipes (without the supply pipes) is calculated for each time step and written into the result file (one per hour). Hence, the pressure drop in the result file represents only the pipe itself, without the supply pipe and without the pressure drop in the evaporator, etc.

- 8.3-8.10 The input of the nominal pressure drop of single components at nominal mass flow rates. The nominal mass flow rate can vary for each component. The conversion to the effective pressure drop is done with the parable approach.
- 8.11 The length of the supply pipe (normally from the head to the manifold of the pipe). The program EWS calculates the total pressure drop from the pressure drop of the borehole plus the sum of the single components from the borehole loop plus 2 times the pressure drop from the supply pipe (from and to the borehole).
- 8.12 The number of parallel inlet pipes for the pressure drop calculation (from the head of the pipe to the manifold). E.g. if the pipes of a double-U-pipe go separately towards the manifold, the input in field 8.12 should be 2, but if the pipes are united at the head of the pipe, the correct input is 1. It is the same behavior if two boreholes are entering the house by a manifold. If the pipes of two double-U-pipes are going separately to the manifold, the correct input in the field 8.12 is 4. If the pipes are united at each head of the two double-U-pipes, a 2 should be entered. If the manifold is very close to the two double-U-pipes and there is a long supply pipe to the house, the input is 1.
- 8.13 The inner diameter of the supply pipes (normally from the head of the pipe to the manifold). The inner diameter of the inlet pipe DN 40 usually is 0.032 m (for DN 50 it is 0.037 m).
- 8.14-8.15 The number of immersion sleeves and bows in the borehole loop (enter the number of the total loop, add the bows in the inlet and outlet pipe). The pressure drop is calculated with

$$\Delta p = \zeta \frac{\rho_{Sole}}{2} v^2 \tag{eq. 3.3}$$

in which $\zeta = 2$ is entered for each bow and $\zeta = 1$ for each immersion sleeve.

- 8.16 The pressure drop for the hole borehole loop. Please note that after each change of any input data, the button “Calculate” must be pressed to adjust the result.

The pressure drop Δp of the flow in the borehole and in the inlet pipe is calculated with:

$$\Delta p = \xi \frac{2H}{D_i} \frac{\rho_{Sole}}{2} v^2 \tag{eq. 3.4}$$

In the laminar case ($Re < 2'300$), ξ is calculated with:

$$\xi = \frac{64}{Re} \tag{eq. 3.5}$$

In the turbulent case ($Re > 2'300$) the approach by Petukhov is used:

$$\xi = [0.790 \ln(Re) - 1.64]^{-2} \tag{eq. 3.6}$$

All other pressure drops are converted from the nominal mass flow to the effective borehole mass flow using the parabolic approach.

- 8.17 Information about the flow regime in the borehole (laminar or turbulent). The transition between laminar and turbulent flow occurs at a Reynolds number of 2'300.

3.13 Properties of the heat pump and of the supplementary heating system

The complete version of the program EWS is able to include additional information about the heat pump as well as about the additional heating system. Select the sheet “Heat pump” from the pull-down menu “Windows” in the menu bare (see Fig. 3.40). In the following the sheet “heat pump” appears (see Fig. 3.41). The sheet “Heat Pump” can not be combined with the sheet “Load”.

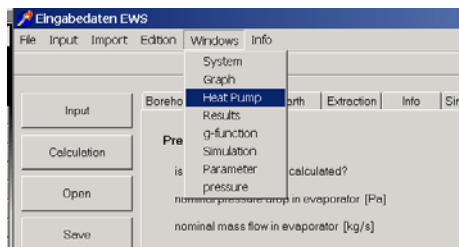

Fig. 3.40: The opening of the sheet “heat pump”.

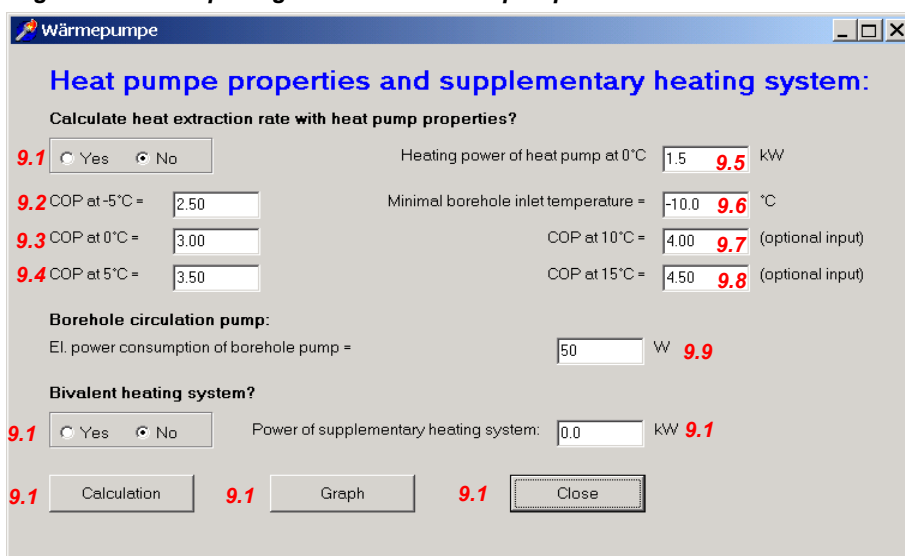

Fig. 3.41: The input mask of the heat pump properties and the additional heating system.

9.1 The inputs from this mask are used for the calculation, if the question “Calculate heat extraction rate with heat pump properties?” is answered with “yes”. In a first step, the program checks the consistency of the input data in field 9.5 (heating power of the heat pump), in field 9.3 (COP at 0°C borehole outlet temperature) and in field 4.4 (evaporator power, extraction rate). In the case of inconsistent input data, the program EWS asks if the input in field 4.4 should be adjusted. If then the field 4.4 is not adjusted, field 9.5 is ignored for all further calculations.

The extraction rate Q_{outlet} (field 4.4) is taken as the evaporator power at 0°C if “yes” is selected in field 9.1. In each calculation step the effective evaporator power is adapted to the effective COP. Thereby, the program EWS assumes a constant heating power (corresponding to the input in field 9.5).

9.2-9.4, 9.7-9.8 In these fields the COP of the various fluid temperatures are entered. The inputs in field 9.7 and 9.8 are optional. If these values are not known, these fields can be set to zero and the program calculates them by a linear extrapolation.

9.9 The electric power consumption of the borehole pump ought to be entered in this field.

9.10/9.11 In case of a bivalent heating system, the power of the supplementary heating system can be entered in the field 9.11. The field 9.10 must be set to “yes” (applied only in the case of a complete “system simulation”).

3.14 Direct cooling

The complete version of the program EWS offers the option to enter data about the direct cooling. Select the sheet “System” from the pull-down menu “Windows” in the menu bare (see Fig. 3.42). In the following the sheet “System” appears (see Fig. 3.43).

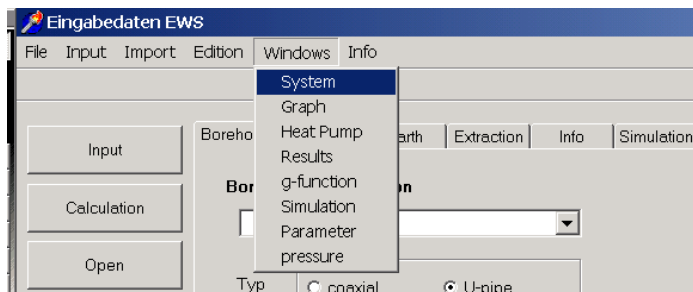

Fig. 3.42: Selection of the input mask “System” of the direct cooling.

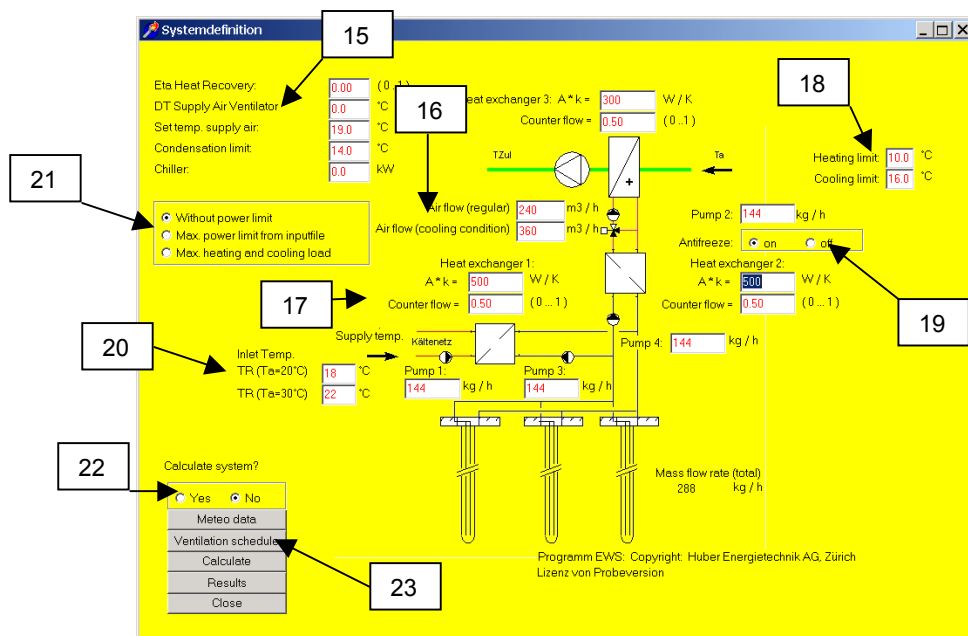

Fig. 3.43: The input mask “System” for direct cooling systems (without HP).

15. The following data must be entered in field 15 (top down): The degree of the efficiency of the heat recovery system, the temperature rise in the supply air ventilator, the desired temperature of the supply air (maximum supply temperature), the condensation limit (minimum supply temperature) and the installed cooling power of an additional chiller (not shown).
16. The regular air flow and the air flow in cooling condition are entered here.
17. Field 17 requires the characteristics of the various heat exchangers in the system (3 units). Additionally, there are 4 pumps available for which the mass flow rate must be entered.
18. The input in field 18 defines the heating and cooling limits. If the outdoor temperature is higher than the cooling limit, the system is in cooling mode, if the outdoor temperature is lower than the heating limit, the system is in heating mode.

19. The program offers the option to protect the heat exchanger to the borehole loop against freezing by controlling the flow rate in the intermediate loop between the air heat exchanger and the borehole heat exchanger. To activate this, put the “Antifreeze” option button **field 19** to “on”.
20. The return temperature of the cooling system in the building, in function of the outdoor air temperature can be defined in **field 20**. Set the value for the return temperature, if the outdoor air temperature is 20°C and if it is 30°C. In between, the system interpolates linear. Below 20°C outdoor air temperature und above 30°C outdoor air temperature it is assumed a constant return temperature of the cooling system.
21. In **field 21** is defined whether it is calculated without a limit of the direct cooling rate, or with the maximal cooling rate from the input file or if the maximal heating and cooling load should be calculated with data from the sheet “Extraction”. This option should always be checked calculating variants.
22. If “yes” is selected in **field 22**, all calculations are done with the data from this input mask. If “no” is selected, the inputs of this sheet are ignored.
23. Click on the button “Ventilation schedule” to define a ventilation schedule.

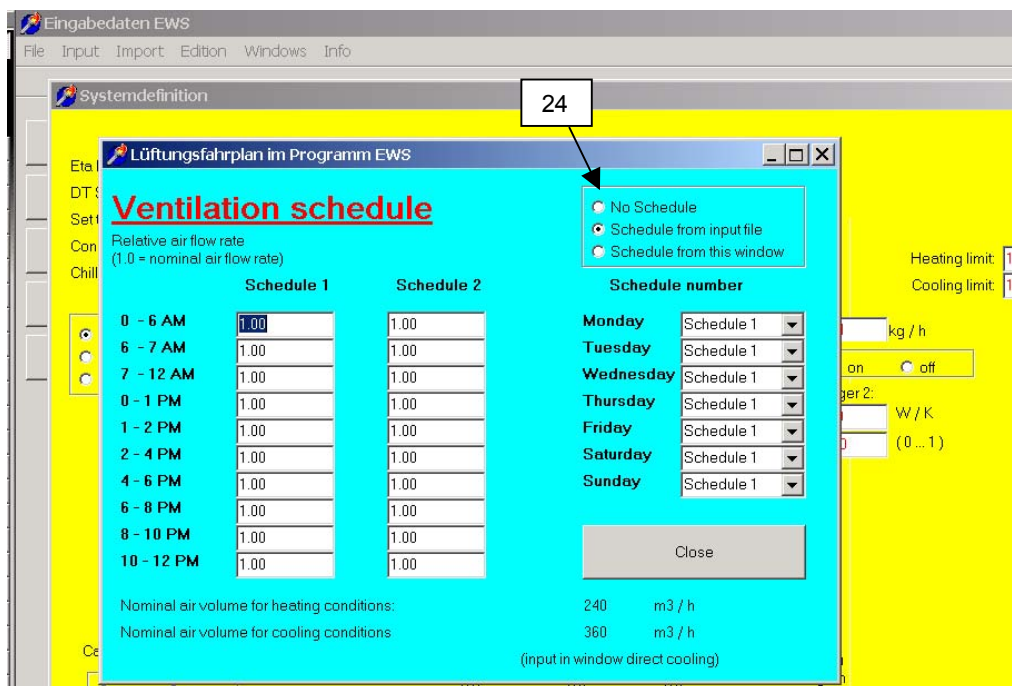

Fig. 3.44: The input mask “Ventilation schedule”.

24. The program EWS is able to generate a ventilation schedule. It exists also the possibility to define an hourly ventilation schedule for the whole year in the input file. Without defining a schedule, the Ventilation rate is kept constant with the values given in **field 16**.

4 Calculations

4.1 Diagram of the inlet and outlet temperature of the borehole fluid

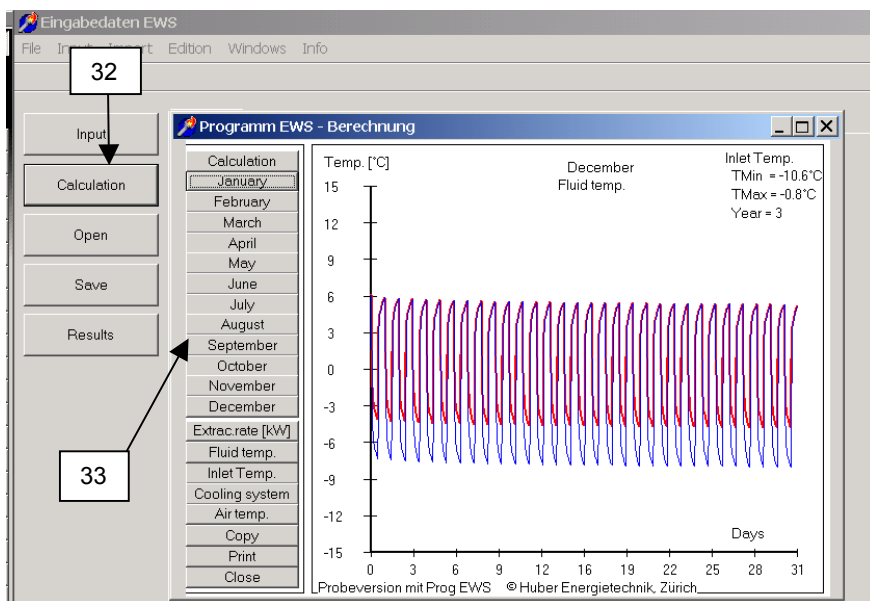

Fig. 4.1: Diagram of the inlet and outlet temperature of the fluid in January.

32. If all fields are completed correctly, the simulation is executed and illustrated by clicking on the button “Calculation”.

The red line (outlet temperature) and the blue line (inlet temperature) in the diagram give the fluid temperature of the corresponding month. The two extreme values given in the right, upper corner represent the minimal and the maximal temperature (T_{min} and T_{max}) during the hole simulation period.

33. The results for each month can be viewed, printed or copied (e.g. into a word file) by clicking on the required month.

4.2 The diagram of the heat extraction rate

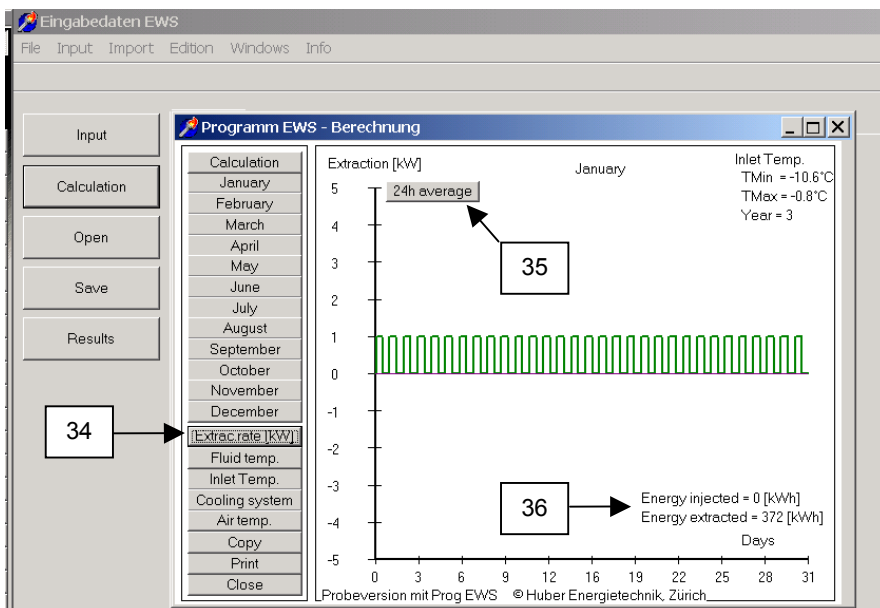

Fig. 4.2: The diagram of the heat extraction rate.

34. The heat extraction rate of the boreholes during each month can be viewed by clicking the button “Extrac. rate”. If the sign of the heat extraction rate is positive, the heat energy is extracted from the boreholes. A negative sign means that heat is injected in the borehole.
35. The averaged heat extraction rate over one day is shown by clicking on the button “24h average”.
36. The cooling and the heating energies of the selected month are shown in the diagram “Extrac. rate”. All input parameters can be saved and opened for a new session by clicking on the button “Open project”.

4.3 The sheet “Results”

Instead of viewing the results in a diagram, the results can be shown in a table, too. The sheet “Results” is opened by selecting the sheet “Results” from the pull-down field “Windows” in the menu bar.

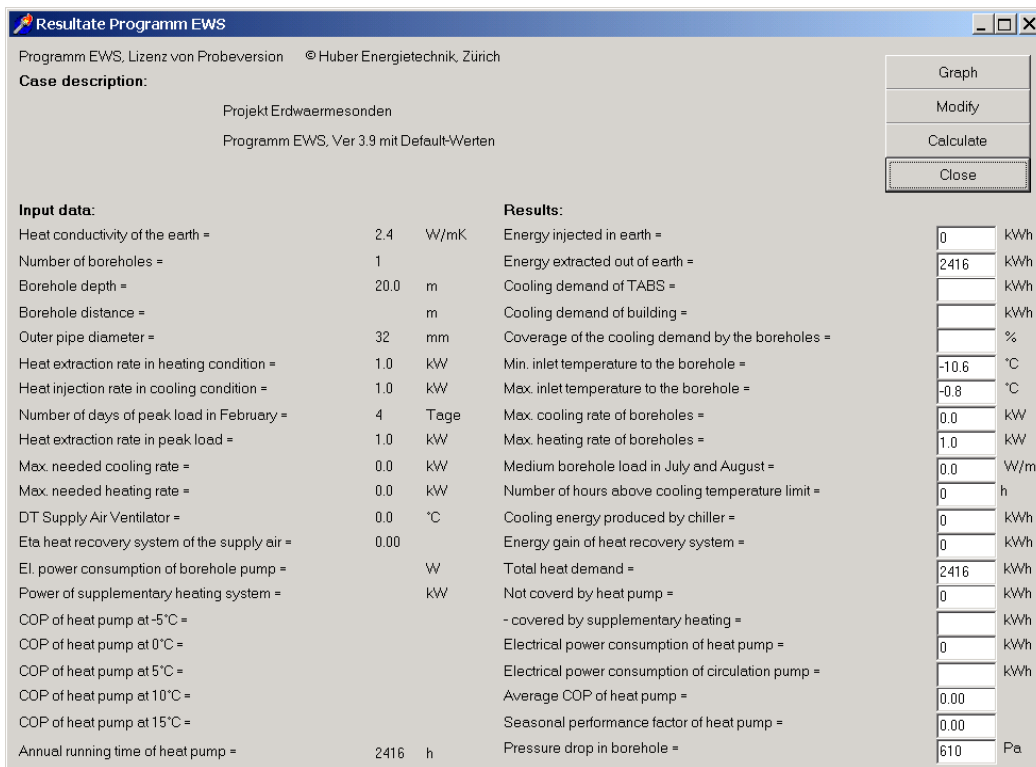

Fig. 4.3: The sheet “Results”.

The following points must be taken into account:

- The indicated pressure loss for the designed mass flow rate considers only the borehole heat exchanger (without the pressure loss in the supply pipe and in the vaporizer). The pressure loss of the hole borehole heat exchanger loop and information about laminar or turbulent flow in the borehole can be found in the sheet “Pressure” (chapter 3.12). Additionally, the result file shows hourly pressure loss values.
- The total heat demand: If the load was defined with the sheet “Extraction” (chapter 3.7) this field shows the sum of the heat extraction of the borehole during the last year. If the load was defined with the sheet “Load” (chapter 3.8) the field “total heat demand” indicates the heat demand of the building.
- The cooling demand of the building is only indicated if the load profile was entered in the sheet “Load” (chapter 3.8).

5 ANNEX A: Description of the model

Extractions of the models in the EWS Program are given in the following. However, only the parts are shown which are required for the comprehension of the input parameters. A more complete model description can be found in [5], [6] and [8].

5.1 Simulation area

The vertical heat conduction close to the borehole (< 3m distance to the borehole) has only a marginal influence on the ground temperature in this area, when the borehole depth is more than 50 m. Therefore, for this area the calculations neglects the vertical heat conduction. As a consequence, the heat equation in cylindrical coordinates can be solved one-dimensional for each layer. Thus, it is possible to define different layer properties. This allows to calculate the common case in which the ground consists of various layers with different properties.

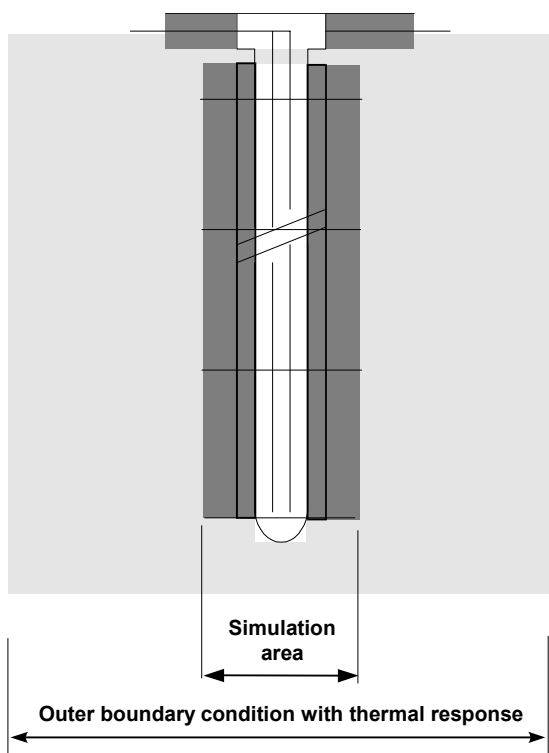

The Crank-Nicholson-method is used for the simulation of the ground temperatures close to the boreholes (< 3m).

The averaged fluid temperature of the corresponding layer is taken as an inner boundary condition. The fluid is simulated unsteady with an explicit time step procedure. Thus, it is possible to calculate the start-up behavior of the borehole.

The outer boundary condition is calculated with the dimensionless thermal response factor (g-functions, see 5.3.3). There is the option to chose between the method of Carslaw & Jaeger [1] or the one of Eskilson [3]. The problem of the inconstant heat extraction rate and the regeneration of the earth can be solved by the superposition of an optional number of constant heat extraction rates which start at different times.

The chosen method allows us to use different time steps within the program: The shortest time step is used for the unsteady calculation of the fluid, while the

Crank-Nicholson calculation in the simulation area is done with a larger time step. Even a time step of one week is sufficient for the calculation of the ground with the g-functions outside of the simulation area. The different time steps are plausible because of the following reasons: The smallest time step is needed close to the boreholes since temperature disturbances always come from the boreholes. Farther from the boreholes only averaged heat extractions or inputs are observed. The use of different time steps allows us to simulate the boreholes with less computing time (compared to other methods) and without a loss of accuracy.

5.1.1 The simulation of the time step

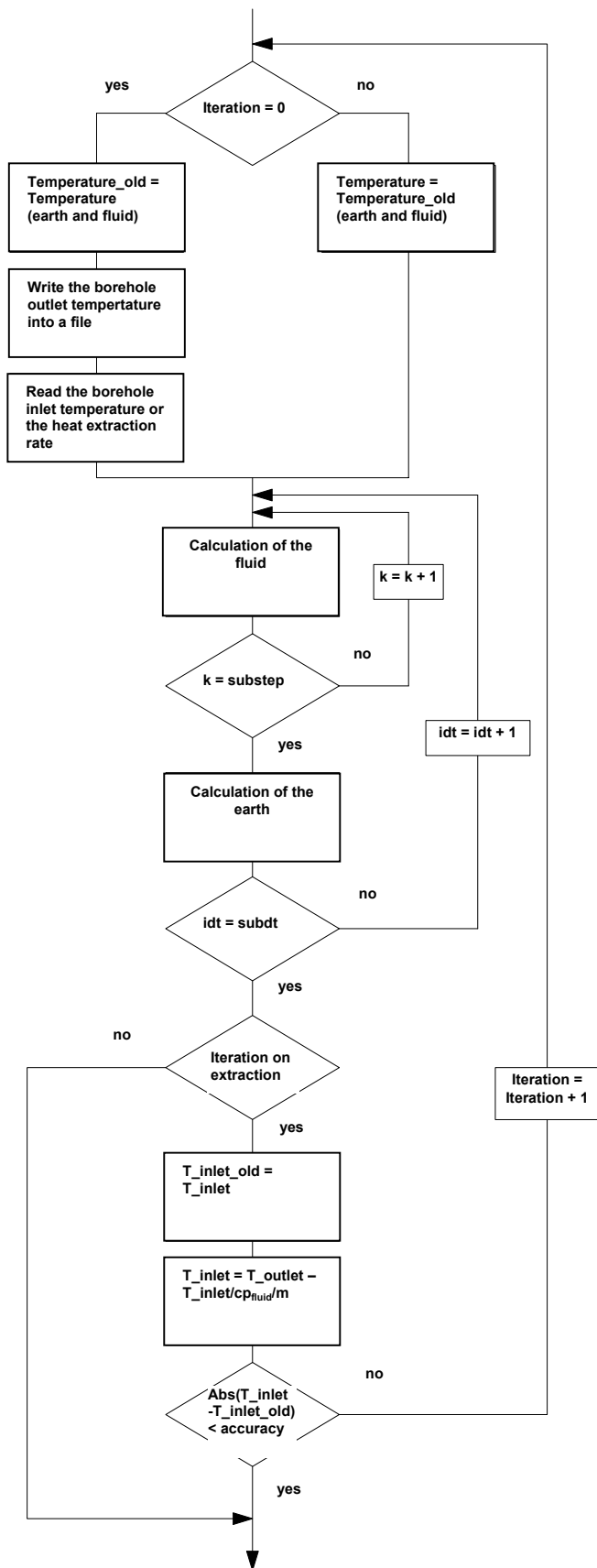

Basically, there are two operation modes for boreholes:

1. Cooling of the borehole outlet temperature with a given heat extraction (Q_{Outlet} , [kW]) of a heat pump.
2. Heating or cooling of the borehole to a given temperature (T_{Inlet}) during a process (e.g. use of the borehole for the cooling of a building).

The program EWS provides both operation modes. The iteration goes towards the extraction rate if the input parameter "heat extraction rate given" is set to "yes" (field 6.2). No intern iteration is done if "no" is selected in the field 6.2. In this case the borehole outlet temperature (T_{Outlet}) is calculated for a given borehole inlet temperature (T_{Inlet}). Therefore, the input of the borehole inlet temperature is necessary. The entered borehole inlet temperature is only used as a first approximation for the start of the iteration if field 6.2 is set to "yes".

5.2 Calculation grid

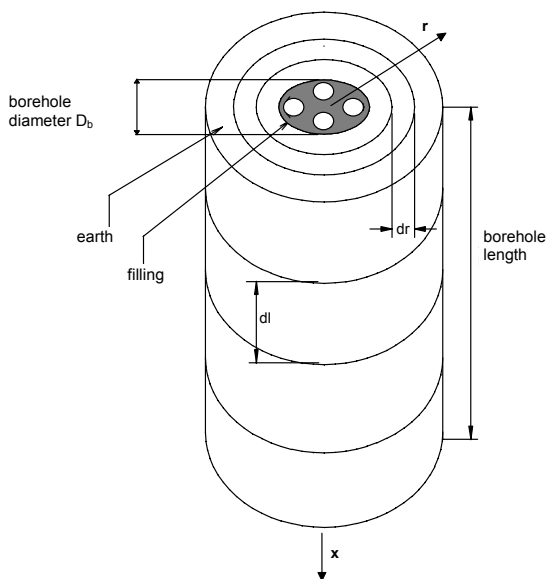

The calculations are done in an axially symmetric grid. The ground is divided in the axial direction into equal segments of the length dl.

The grid is variable in the radial direction. The grid is defined by the grid factor f:

$$\text{Gitterfaktor } f = \frac{r_{j+1} - r_j}{r_j - r_{j-1}} \tag{eq. 5.1}$$

The grid can be calculated as given in eq. 5.2 to eq. 5.4 if the simulation area is set to the maximal calculation radius r_m , whereof m represents the number of calculation point in the radial direction:

Fig. 5.1: The simulation grid of the borehole.

$$r_0 = \frac{D_i}{2} \tag{eq. 5.2}$$

$$r_1 = \frac{D_b}{2} = \frac{\text{borehole diameter}}{2} \tag{eq. 5.3}$$

$$\text{for } j \geq 2: \quad r_j = r_{j-1} + (r_m - r_1) \frac{1-f}{1-f^{m-1}} f^{j-2} \tag{eq. 5.4}$$

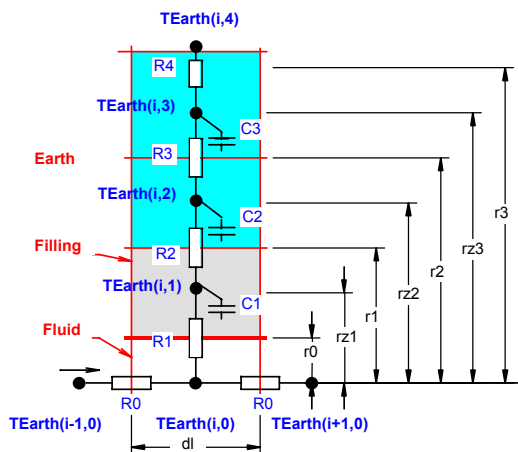

A grid factor of 2 doubles the difference of the radius between two calculation volumes.

The mass balance point, which is important for the determination of the thermal resistance, can be calculated as showed below:

$$\text{Def: } rz_j = \sqrt{\frac{(r_j^2 + r_{j-1}^2)}{2}} \tag{eq. 5.5}$$

Fig. 5.2 The calculation grid of the borehole.

5.3 Heat Equation and the thermal response g

5.3.1 Heat Equation

For the following considerations it is assumed that the dominant heat transport mechanism in the earth is the heat conductivity. Hence, the convective heat transport by water flows in the earth is negligible. The problem of the heat conductivity of the earth around a borehole is axially symmetric. The heat equation in radial direction around a borehole can be written as

$$\frac{1}{a} \cdot \frac{\partial T_{\text{Earth}}}{\partial t} = \frac{\partial^2 T_{\text{Earth}}}{\partial r^2} + \frac{1}{r} \cdot \frac{\partial T_{\text{Earth}}}{\partial r} \quad \text{eq. 5.6}$$

thereby the thermal diffusivity a is defined with

$$\text{Def: } a = \frac{\lambda}{c p_{\text{Earth}} \cdot \rho_{\text{Earth}}} \quad \text{eq. 5.7}$$

The heat equation is linear. Hence, single boreholes as well as borehole fields with geometric similarity have similar thermal responses.

Thus, the heat extraction rate from a borehole causes a temperature drop ΔT_{Earth} in the earth around the borehole compared to the unaffected earth (= temperature funnel). This funnel grows with the ongoing extraction. The temperature drop ΔT_{Earth} can be made dimensionless by using the specific extraction rate \dot{q} and the heat conductivity λ_{Earth} :

$$\text{Def: } g(r, t) = \frac{\Delta T_{\text{Earth}}(r, t) 2\pi \lambda_{\text{Earth}}}{\dot{q}} \quad \text{eq. 5.8}$$

5.3.2 The radial temperature funnel

In the steady case the radial heat flow in the borehole close-up range is constant and the following equation can be used:

$$\frac{\dot{q}}{2 \cdot \pi \cdot r} = \frac{\partial T_{\text{Earth}}}{\partial r} \cdot \lambda_{\text{Earth}} = \frac{\partial g}{\partial r} \cdot \frac{\dot{q}}{2 \cdot \pi} \quad \text{eq. 5.9}$$

The integration from r to r_1 gives:

$$g(r) = g(r_1) - \ln\left(\frac{r}{r_1}\right) \quad \text{eq. 5.10}$$

This relation allows us to estimate the temperature behavior of the borehole with a single thermal response. Additionally, if the thermal response g on the point r_1 is known, it can be concluded on the thermal response g on point r . But please note that the assumption of the steady case can produce major deviations for little time steps.

5.3.3 The dimensionless thermal response g

Carslaw & Jaeger [1] solved the heat equation for infinite line sources analytically and found for g the following relation:

$$g = \frac{1}{2} \cdot \left[-\gamma - \ln\left(\frac{r^2}{4 \cdot t \cdot a}\right) - \sum_{n=1}^{\infty} (-1)^n \frac{\left(\frac{r^2}{4 \cdot a \cdot t}\right)^n}{n \cdot n!} \right] \cong \frac{1}{2} \cdot \left[\ln\left(\frac{4 \cdot t \cdot a}{r^2}\right) - \gamma \right] \quad \text{eq. 5.11}$$

in which $\gamma=0.5772..$ is the Euler constant.

Werner, A.; Bigler, R.; Niederhauser, A. et. al. [14] got an identical solution using an analogy from the water well equation. In the program EWS, equation eq. 5.11 is implemented. This equation can be used for an outer boundary condition of the simulation area as an alternative to the g-function by Eskilson.

The approach by Carslaw and Jaeger leads to a continuous growth of the temperature funnel since for an infinite line source neither the inflow of heat from the top nor from the bottom is possible (due to symmetrical reasons). No equilibrium condition can be reached with the approach by Carslaw and Jaeger. The University of Lund developed an approach for boreholes with a finite borehole length H. This, because finite boreholes use primarily the heat which is stored in the earth through the surface.

According to Claesson and Eskilson [2] the boreholes have a time constant t_s , with which the temporal behavior of the ground around the borehole can be made dimensionless:

$$t_s = \frac{H^2}{9a} \quad \text{eq. 5.12}$$

Thus, the dimensionless Eskilson number E_s

$$E_s = \frac{t}{t_s} = \frac{9a}{H^2} t \quad \text{eq. 5.13}$$

can be treated as a dimensionless time for single boreholes and fields of boreholes. Further information on this topic can be found e.g. at Loose [18].

Especially for unbalanced, annual heat extraction balances the knowledge of the time constant t is fundamental. The equilibrium condition between heat extraction and heat inflow from the surrounding earth is reached after approximately $E_s = 10$.

For a single borehole, the dimensionless thermal response g (= "g-function") by Eskilson (1987) is only a function of the dimensionless time E_s and the dimensionless borehole distance r_b/H . This is based on the assumption of a constant, specific heat extraction rate per borehole length (\dot{q}).

For single boreholes within a range of $5r_1^2/a < t < t_s$ the g-function can be approached with a maximal deviation of 7% by

$$g(t, r_1) = \ln\left(\frac{H}{2r_1}\right) + 0.5 \ln(Es) \tag{eq. 5.14}$$

For time periods longer than t_s , the single borehole converge to the following equilibrium condition:

$$g(r_1) = \ln\left(\frac{H}{2 \cdot r_1}\right) \tag{eq. 5.15}$$

As an example, the g-function of two boreholes in a distance B between the boreholes is shown in Fig. 5.3. As a comparison, the g-function of a single borehole is illustrated with a dashed line. Other thermal responses for borehole fields can be found in the ANNEX.

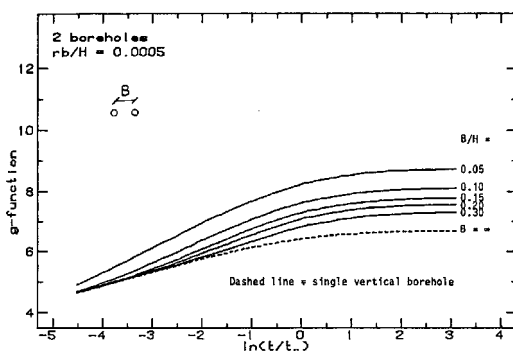

Fig. 5.3 The dimensionless thermal response g for 2 boreholes with a distance B by [3].

5.3.4 The comparison of the models

In Fig. 5.4 the approach by Carslaw & Jaeger for an infinitely deep borehole is compared to the approach by Eskilson for a borehole with a depth of 10m, 100m and 500m, respectively. There is almost no deviation of the models observed until the time constant t_s is reached.

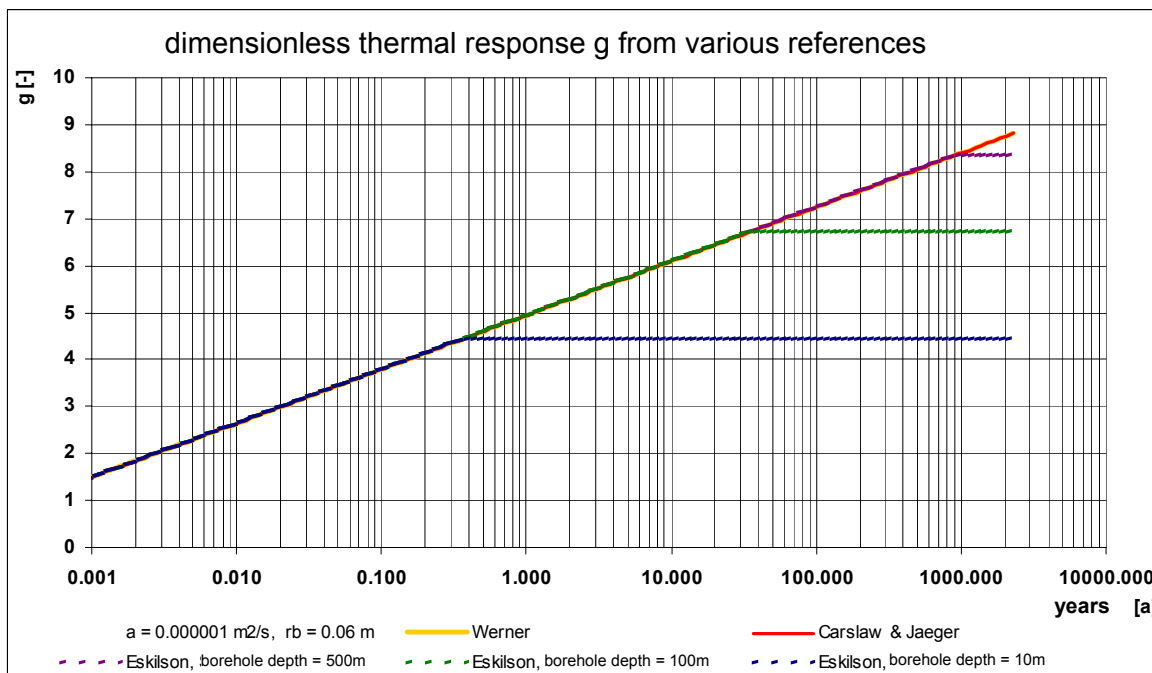

Fig. 5.4 The dimensionless thermal response g by Carslaw & Jaeger [1] and Eskilson [3]

5.4 The calculation of the g-function with the principle of superposition

Normally, each borehole in a field of boreholes is fed with a fluid of the same borehole inlet temperature by a manifold. Hence, the load is attached parallel to all boreholes. In this case the g-function of a borehole field can be approached by the superposition of various single boreholes. We do not have to think about a deviation for shorter time steps (unsteady effects) since the program EWS only uses the g-functions as an outer boundary condition which usually is calculated in time steps of one week. Thus, the accuracy of the steady equation is sufficient to approximate the influence of the borehole field on a single borehole x. The borehole distance A_{xy} between the borehole x and the borehole y is used instead of r_1 :

$$g_x(r) = g(r_1) - \ln\left(\frac{r}{r_1}\right) + \sum_{y=1}^{y=n/x < y} \left(g(r_1) - \ln\left(\frac{A_{xy}}{r_1}\right) \right) \quad \text{eq. 5.16}$$

With a parallel operation of the boreholes, the g-function of the whole borehole field can be calculated with the average value of all n boreholes:

$$g(r) = g(r_1) - \ln\left(\frac{r}{r_1}\right) + \frac{1}{n} \cdot \sum_{x=1}^{x=n} \left[\sum_{y=1}^{y=n/x < y} \left(g(r_1) - \ln\left(\frac{A_{xy}}{r_1}\right) \right) \right] \quad \text{eq. 5.17}$$

5.5 The borehole temperature T_b and the fluid temperature T_f

The thermal response ΔT has to be subtracted from the undisturbed earth temperature at the beginning T_m to get the temperature in the earth (principle of superposition). The temperature on the border of the borehole $T_{Earth}(r_1)$ (=borehole temperature T_b) can be calculated from g and T_m with:

$$T_b(z) = T_m(z) - R_g \cdot \dot{q} = T_m(z) - \frac{\dot{q}}{2 \pi \lambda_{Earth}} g(t, r_1) \quad \text{eq. 5.18}$$

T_m is the averaged earth temperature in the depth z under undisturbed conditions. It is calculated with the averaged, annual surface temperature of the earth T_{mo} and the temperature gradient ΔT_{Grad} .

The averaged, annual surface temperature is equal to the averaged air temperature plus a mean surface warming which usually is between 0.8 and 2°C. The temperature gradient ΔT_{Grad} typically ranges from 0.025 to 0.045 K/m.

The mean borehole temperature over the borehole depth $\overline{T_b}$ is defined as

$$\text{Def } \overline{T_b} = \frac{1}{H} \cdot \int_0^H T_b(z) \cdot dz \quad \text{eq. 5.19}$$

In the case of a constant heat extraction rate per borehole length (\dot{q}) it is possible to calculate the mean borehole temperature over the borehole depth $\overline{T_b}$ with

$$\overline{T_b} = \overline{T_m} - R_g \cdot \dot{q} = \overline{T_m} - \frac{\dot{q}}{2 \pi \lambda_{Earth}} g(t, r_1) \quad \text{eq. 5.20}$$

thereby is

$$\overline{T_m} = T_{mo} - \Delta T_{Grad} \cdot \frac{H}{2} \quad \text{eq. 5.21}$$

5.5.1 The fluid temperature T_f

The mean fluid temperature T_f is defined as the arithmetic mean of the upward and downward flowing borehole fluid.

$$\text{Def: } T_f(z) = \frac{T_{up}(z) + T_{down}(z)}{2} \tag{eq. 5.22}$$

Hence, the fluid temperature T_f is a function of the depth z in the borehole. The mean fluid temperature \overline{T}_f is defined as

$$\text{Def: } \overline{T}_f = \frac{1}{2} \cdot (T_{Outlet} + T_{Inlet}) \tag{eq. 5.23}$$

5.6 Thermal resistances R_a and R_b in the double-U-pipe

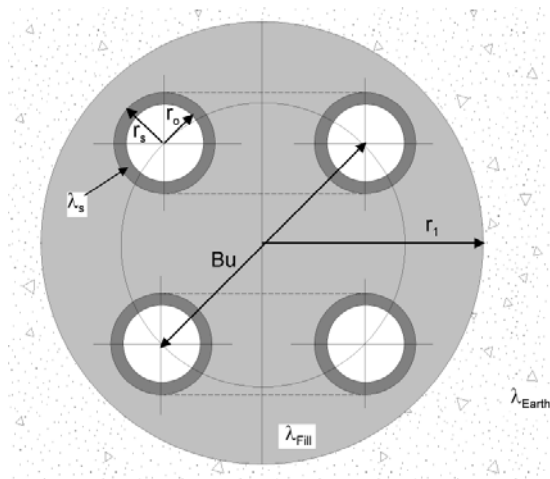

An idealized double-U-pipe with the borehole radius r_1 and 4 borehole pipes (with an inner radius r_o and an outer radius r_s) is shown in the picture on the left. In two borehole pipes the borehole fluid is flowing downward while in the other pipes the fluid flows upward. The heat conductivity of the filling is λ_{Fill} , the one of the borehole λ_s and the surrounding earth's heat conductivity is λ_{Earth} . The exact position of the 4 borehole pipes can be described with the eccentricity parameter b .

$$b = \frac{Bu}{2 \cdot r_1} \tag{eq. 5.24}$$

Fig. 5.5 The nomenclature on the double-U-pipe.

The eccentricity parameter b is defined by the pipe distance Bu ("shank spacing") (see Fig. 5.5). The geometrically maximal limit of the eccentricity b_{Max} is:

$$b_{Max} = \frac{2 \cdot r_1 - 2 \cdot r_s}{2 \cdot r_1} = 1 - \frac{r_s}{r_1} \tag{eq. 5.25}$$

The geometrically minimal limit of the eccentricity (for a not centered borehole pipe) is:

$$b_{Min} = \frac{r_s}{r_1} \tag{eq. 5.26}$$

The conductivity parameter σ is defined as a pure substance property by

$$\sigma = \frac{\lambda_{Fill} - \lambda_{Earth}}{\lambda_{Fill} + \lambda_{Earth}} \tag{eq. 5.27}$$

The intern thermal borehole resistance R_a [Km/W] is a characteristic value for the thermal losses Δq_i [W/m] (related to the length) of the upward flowing fluid to the downward flowing fluid. R_a is independent of the depth of the borehole:

$$\text{Def: } R_a = \frac{T_{up}(z) - T_{down}(z)}{\Delta q_i(z)} \tag{eq. 5.28}$$

The thermal borehole resistance R_b is defined by the mean fluid temperature T_f in the borehole and the borehole temperature T_b :

$$\text{Def: } R_b = \frac{T_b(z) - T_f(z)}{\dot{q}} \tag{eq. 5.29}$$

The borehole resistance R_b is independent of the borehole depth and consists of the resistance of the borehole filling R_c and the resistance of the heat transfer from the filling to the borehole fluid R_α :

$$R_b = R_\alpha + R_c \tag{eq. 5.30}$$

The resistance of the heat transfer R_α can be calculated for double-U-pipes with

$$R_\alpha = \frac{1}{8 \cdot \pi \cdot \alpha \cdot r_o} \tag{eq. 5.31}$$

5.6.1 The internal borehole resistance R_a by Hellström [4]

According Hellström [4] (1991, S. 147, 9.149) the internal borehole resistance R_a for double-U-pipes with a symmetric configuration of the pipes can be calculated with

$$R_a = \frac{1}{\pi \cdot \lambda_{\text{Fill}}} \left[\ln\left(\frac{\sqrt{2} \cdot b \cdot r_1}{r_o}\right) - \frac{1}{2} \cdot \ln\left(\frac{2 \cdot b \cdot r_1}{r_o}\right) - \frac{1}{2} \cdot \sigma \cdot \ln\left(\frac{1 - b^4}{1 + b^4}\right) \right] + \frac{1}{2 \cdot \pi \cdot r_o \cdot \alpha} + R_s \tag{eq. 5.32}$$

in which the thermal resistance R_s of the pipe wall is calculated with

$$R_s = \frac{1}{2 \cdot \pi \cdot \lambda_s} \cdot \ln\left(\frac{r_s}{r_o}\right) \tag{eq. 5.33}$$

5.6.2 The borehole resistance R_b by Hellström [4]

The borehole resistance for a double-U-pipe can be calculated by Hellström [4] (S. 89, eq. 8.69) with

$$R_b = \frac{1}{8 \cdot \pi \cdot \lambda_{\text{Fill}}} \cdot \left[\beta + \ln\left(\frac{r_1}{r_o}\right) + \ln\left(\frac{r_1}{Bu}\right) + \sigma \cdot \ln\left(\frac{r_1^4}{r_1^4 - \frac{Bu^4}{16}}\right) - \frac{\frac{r_o^2}{Bu^2} \left[1 - \sigma \cdot \frac{\frac{1}{4} Bu^4}{\left(r_1^4 - \frac{Bu^4}{16}\right)} \right]^2}{\left\{ \frac{1 + \beta}{1 - \beta} + \frac{r_o^2}{Bu^2} \left[1 + \sigma \cdot \frac{Bu^4 \cdot r_1^4}{\left(r_1^4 - \frac{Bu^4}{16}\right)^2} \right] \right\}} \right] \tag{eq. 5.34}$$

and

$$\beta = 2 \cdot \pi \cdot \lambda_{\text{Fill}} \cdot [R_\alpha + R_w] = \lambda_{\text{Fill}} \cdot \left[\frac{1}{r_o \cdot \alpha} + \frac{1}{\lambda_s} \cdot \ln\left(\frac{r_s}{r_o}\right) \right] \tag{eq. 5.35}$$

5.7 Thermal resistances R_a / R_b of a coaxial borehole

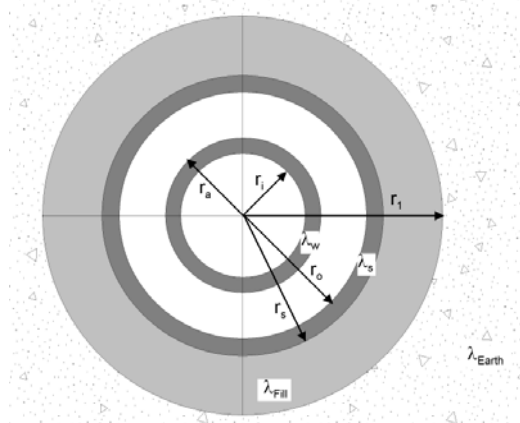

Nomenclature of a coaxial borehole

The idealized coaxial borehole is shown in Fig. 5.6. The borehole with the borehole radius r_1 is colored in gray.

The filling has the heat conductivity λ_{Fill} , the inner borehole pipe λ_w , the outer borehole pipe λ_s and the earth λ_{Earth} .

The inner and the outer radii of the inner borehole pipe are r_i and r_a . The inner and the outer radii of the outer borehole pipe are r_o and r_s .

Fig. 5.6 Nomenclature of a coaxial borehole.

5.7.1 Modeling of the inner borehole resistance R_a

The definition of the inner borehole resistance R_a in eq. 5.28 is valid for the coaxial borehole, too. Hence, the thermal resistance is the sum of the heat transfer resistances of the upward flowing fluid to the inner borehole pipe (1st term), of the thermal resistance of the inner borehole pipe (2nd term) and of the heat transfer resistance from the inner borehole pipe to the downward flowing fluid (3rd term):

$$R_a = \left[\frac{1}{2 \cdot \pi \cdot r_i \cdot \alpha_i} + \frac{1}{2 \cdot \pi \cdot \lambda_w} \cdot \ln\left(\frac{r_a}{r_i}\right) + \frac{1}{2 \cdot \pi \cdot r_a \cdot \alpha_a} \right] \quad \text{eq. 5.36}$$

5.7.2 Modeling of the borehole resistance R_b

In the case of a coaxial borehole, R_b is defined as the thermal resistance of the outer borehole fluid (normally the downward flowing fluid) to the wall of the borehole (on the radius r_1):

$$R_b = \left[\frac{1}{2 \cdot \pi \cdot r_o \cdot \alpha_o} + \frac{1}{2 \cdot \pi \cdot \lambda_s} \cdot \ln\left(\frac{r_s}{r_o}\right) + \frac{1}{2 \cdot \pi \cdot \lambda_{Fill}} \cdot \ln\left(\frac{r_1}{r_s}\right) \right] \quad \text{eq. 5.37}$$

5.8 The analytical borehole equation

5.8.1 The concept of thermal resistances

The concept of thermal resistances is based on a “steady” condition and postulates a linear relationship between the temperature gradient and the specific heat loss:

$$T_{User} - T_{Heatsource} \equiv \sum R \cdot \dot{q} \tag{Gl. 5.38}$$

The thermal resistance of borehole heat exchanger systems can be split up as follows:



Abb. 5.7: Thermal resistance of a borehole heat exchanger systems

5.8.2 Thermal resistance R_f (evaporator)

In a steady condition, the heat balance of the evaporator and the earth can be written as:

$$(T_{Outlet} - T_{Inlet}) \cdot \dot{m} \cdot cp_{Fluid} = \dot{Q}_{Vaporizer} = \dot{Q}_{Borehole} = H \cdot \dot{q} \tag{eq. 5.39}$$

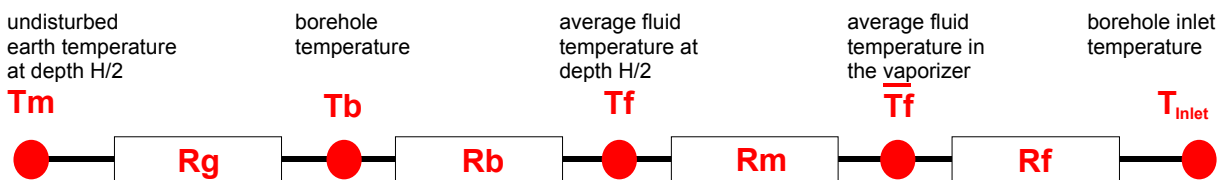
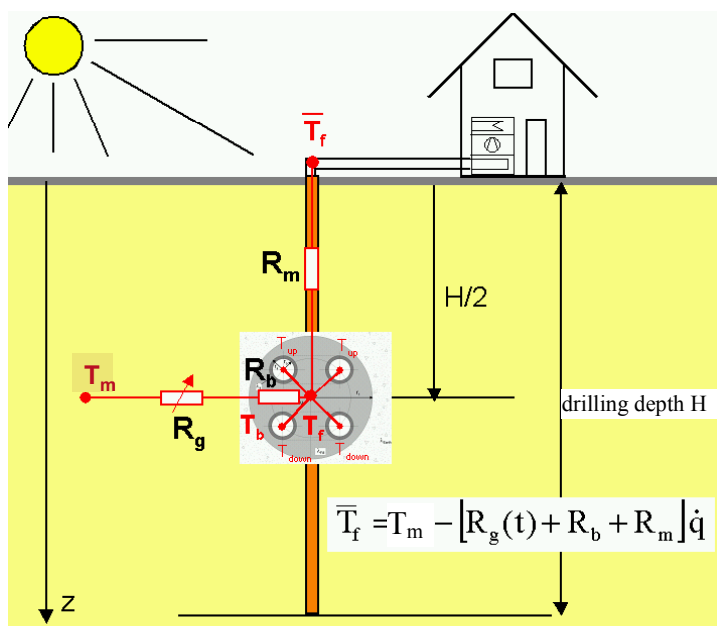
Considering eq. 5.23 the following equation for the **thermal resistance of the evaporator R_f** can be defined as:

$$T_{Outlet} = \bar{T}_f + \frac{H}{2 \cdot \dot{m} \cdot cp_{Fluid}} \cdot \dot{q} \equiv \bar{T}_f + R_f \cdot \dot{q} \tag{eq. 5.40}$$

$$T_{Inlet} = \bar{T}_f - \frac{H}{2 \cdot \dot{m} \cdot cp_{Fluid}} \cdot \dot{q} \equiv \bar{T}_f - R_f \cdot \dot{q} \tag{eq. 5.41}$$

5.8.3 Thermal resistance R_m (temperature loss along the borehole)

In the heat extraction case the highest average fluid temperature T_f is at the bottom of the borehole heat exchanger. During the transportation of the fluid from the bottom, the fluid yield a part of its heat energy to the down flowing fluid and sometimes also to the upper earth layers. Assuming that there is a constant specific heat extraction rate for the entire borehole length (which is a reasonable assumption for most boreholes), the following relationship for the fluid temperature results [8]:

$$T_{up}(z) = T_{mo} + \Delta T_{Grad} \cdot \frac{H}{2} - \left[\frac{g(t, H)}{2\pi \lambda_{Earth}} + R_b + \frac{1}{R_a} \cdot \frac{H^2 - z \cdot H + \frac{z^2}{2}}{\dot{m}^2 \cdot cp_{Fluid}^2} - \frac{H - z}{2 \cdot \dot{m} \cdot cp_{Fluid}} \right] \dot{q} \tag{eq. 5.42}$$

$$T_{down}(z) = T_{mo} + \Delta T_{Grad} \cdot \frac{H}{2} - \left[\frac{g(t, H)}{2\pi \lambda_{Earth}} + R_b + \frac{1}{R_a} \cdot \frac{H^2 - z \cdot H + \frac{z^2}{2}}{\dot{m}^2 \cdot cp_{Fluid}^2} + \frac{H - z}{2 \cdot \dot{m} \cdot cp_{Fluid}} \right] \dot{q} \tag{eq. 5.43}$$



Abb. 5.8: Temperature profile of the fluid according to [8].

Thus, the thermal resistance R_m can be defined as

$$T_f \left(z = \frac{H}{2} \right) - \bar{T}_f \equiv R_m \cdot \dot{q} = \left(\frac{1}{3 \cdot R_a} \cdot \frac{H^2}{\dot{m}^2 \cdot cp_{Fluid}^2} \right) \cdot \dot{q} \tag{eq. 5.44}$$

5.8.4 Thermal resistance of the earth R_g

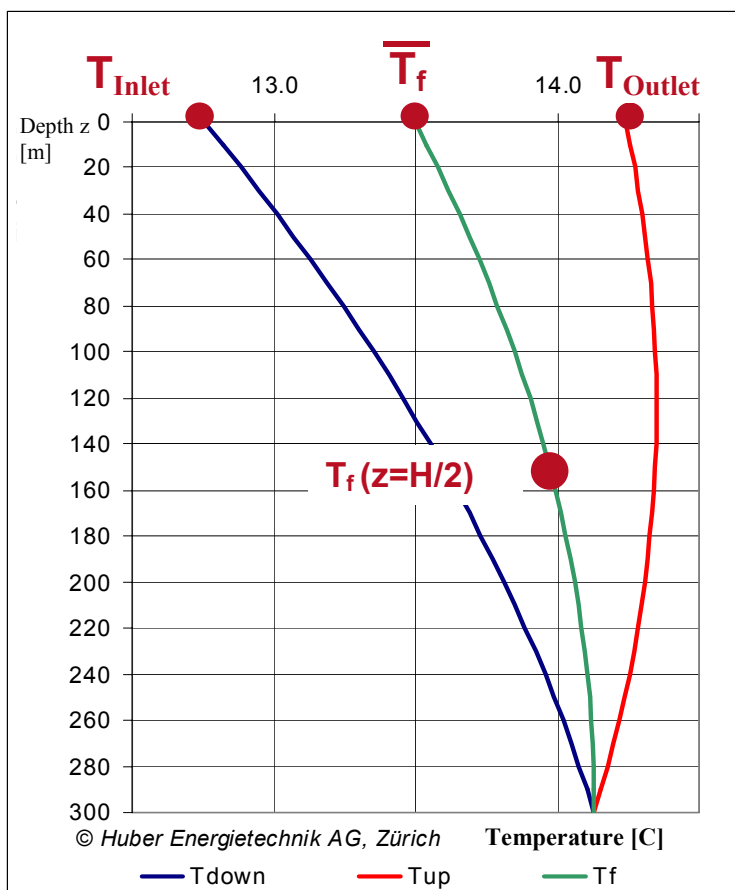
The thermal resistance of the earth R_g follows from the temperature difference between the borehole surface temperature and the temperature level of the undisturbed earth on the same depth. The definition of R_g follows from the definition of the g-function (eq. 5.8):

$$T_m - T_b = \Delta T(r = r_b, t) = \frac{\dot{q}}{2\pi\lambda} \cdot g(r_b, t) = R_g \cdot \dot{q} \tag{eq. 5.45}$$

The particularity of the thermal resistance R_g is that it is a function of the time and that it is permanently increasing under a constant heat extraction rate (see chapter 5.3).

5.8.5 The analytical borehole equation

The analytical borehole equation follows from the combination of the different thermal resistances of the borehole and its surroundings:

$$T_{Outlet} = T_m - (R_g + R_b + R_m - R_f) \cdot \dot{q} \tag{eq. 5.46}$$

$$T_{Inlet} = T_m - (R_g + R_b + R_m + R_f) \cdot \dot{q} \tag{eq. 5.47}$$

Replacing T_m with eq. 5.21, R_g with eq. 5.45 and R_m with eq. 5.44 yield to the analytical borehole equation:

$$T_{Outlet} = T_{mo} + \Delta T_{Grad} \cdot \frac{H}{2} - \left[\frac{g(t, r_1)}{2\pi \lambda_{Earth}} + R_b + \frac{1}{3} \cdot \frac{1}{R_a} \cdot \frac{H^2}{\dot{m}^2 \cdot cp_{Fluid}^2} - \frac{H}{2 \cdot \dot{m} \cdot cp_{Fluid}} \right] \dot{q} \tag{eq. 5.48}$$

and

$$T_{Inlet} = T_{mo} + \Delta T_{Grad} \cdot \frac{H}{2} - \left[\frac{g(t, r_1)}{2\pi \lambda_{Earth}} + R_b + \frac{1}{3} \cdot \frac{1}{R_a} \cdot \frac{H^2}{\dot{m}^2 \cdot cp_{Fluid}^2} + \frac{H}{2 \cdot \dot{m} \cdot cp_{Fluid}} \right] \dot{q} \tag{eq. 5.49}$$



Abb. 5.9: Thermal resistance of a borehole heat exchanger.

The analytical borehole equation is suited perfectly as a tool to assess the dimension of a result or to check the plausibility of a result.

6 ANNEX B: Input of a particular g-function

6.1 Example 1: The input of a g-function by the values of the function

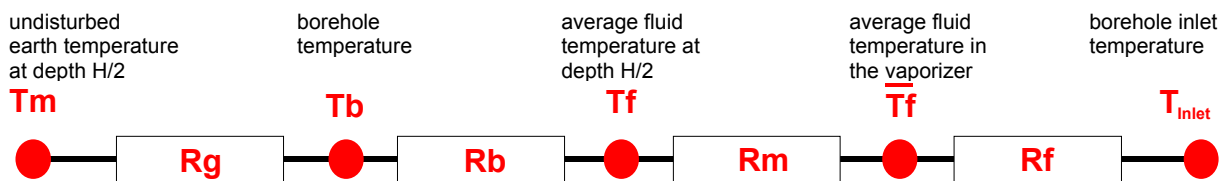
The g-function published by Eskilson [3] with 9 boreholes in a quadratic configuration (see Fig. 6.1) and $B/H = 0.10$ shall be entered. The borehole length is 100 m.

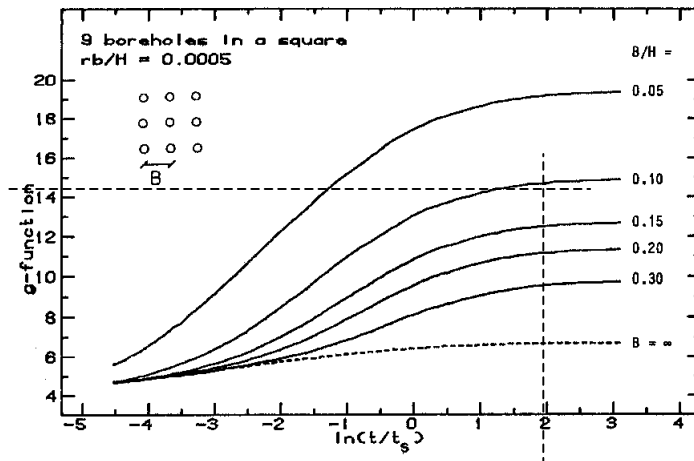

Fig. 6.1: Example of a published g-function (from [3]) and the reading of the function value on the supporting point $\ln(t/t_s) = 2$.

Select the last option in the field 1.11 which is “special input”. Then, select “yes” in the fields 1.10 and 1.13. The function values of the g-function are read from the graph in Fig. 6.1 on the supporting points $\ln(t/t_s) = -4, -2, 0, +2, +3$. The values are: $g[\ln(t/t_s)=-4] = 5.09$, $g[\ln(t/t_s)=-2] = 7.00$, $g[\ln(t/t_s)=0] = 10.86$, $g[\ln(t/t_s)=+2] = 14.68$, $g[\ln(t/t_s)=+3] = 14.91$. These function values are to be entered in the fields 1.15 to 1.19. The borehole distance must be adjusted in field 1.20 in a way that the B/H ratio in field 1.21 is equal to 0.1. This means that the input in field 1.20 must be 10m since the length of the borehole H is given (100m).

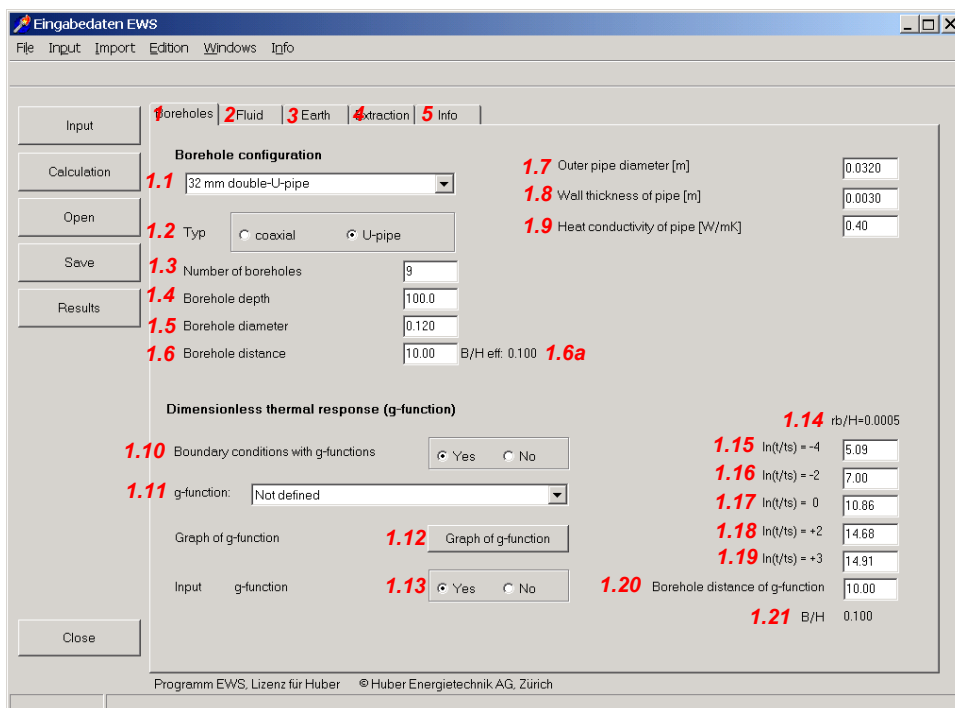

Fig. 6.2: The sheet “Boreholes”, example of a particular g-function for a 3 x 3 borehole field with a quadratic configuration and $B/H = 0.10$.

The entered g-function, respectively the spline-interpolation which is used by the program, can be checked visually and quantitatively by clicking on the field 1.12. It is necessary to adjust the B/H_{eff} ratio (field 1.6) to the B/H ratio of the g-function (field 1.20) if the B/H_{eff} ratio (field 1.6a) differs from the B/H ratio of the g-function (field 1.21). The g-function would be extrapolated from the B/H_{eff} ratio if the adjustment is not done. The graph of the entered g-function is showed in Fig. 6.3.

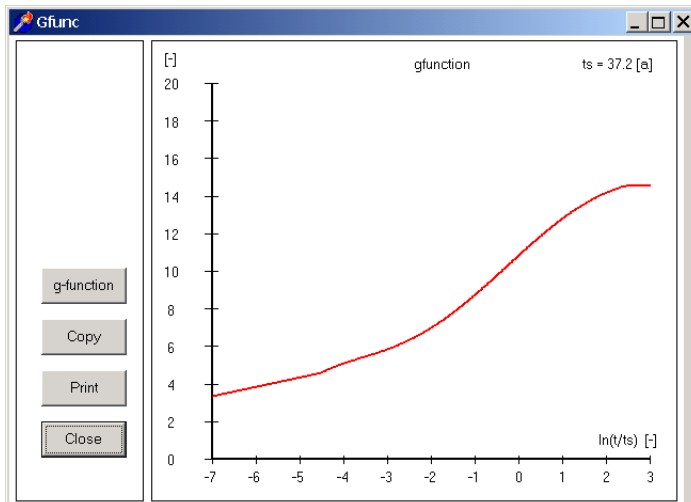

Fig. 6.3: The graph of the particularly entered g-function from Fig. 6.2.

The program EWS uses an automatically extrapolated g-function if the effective ratio B/H_{eff} (field 1.6a) differs from 0.1. This extrapolated g-function can be shown by clicking on the field 1.12. This means for the above example that if the effective borehole distance B is 8 m, this value has to be entered in the field 1.6. Hence, the effective B/H_{eff} ratio is 0.08. The extrapolated g-function (using the value in field 1.12) is shown in Fig. 6.4.

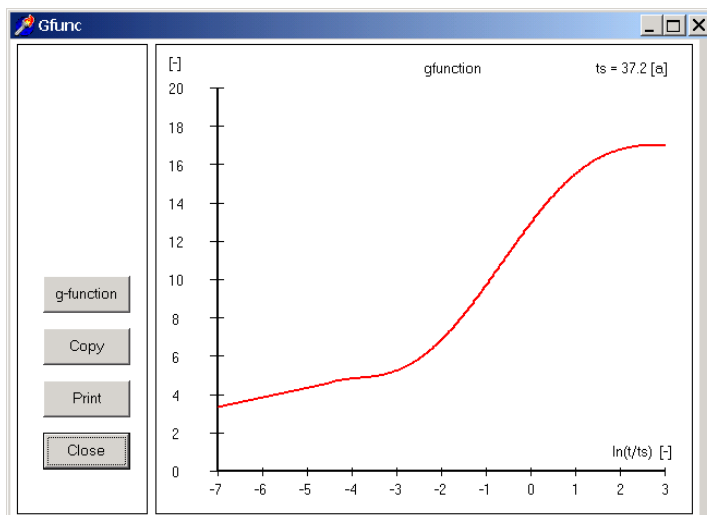

Fig. 6.4: The graph of the g-function in Fig. 6.2 extrapolated from $B/H_{eff} = 0.08$.

7 Table of symbols

7.1 Latin symbols

a	thermal diffusivity	[m ² /s]
b	eccentricity parameter of a double-U-pipe	[-]
B	distance between different boreholes	[m]
B_u	shank spacing between the pipes of the upward and the downward flowing fluid	[m]
cp_{Sole}	specific heat capacity of the fluid	[J/(kgK)]
D_i	inner diameter of the borehole pipe	[m]
Dim_{Axi}	number of calculation nodes in axial direction	[-]
Dim_{Rad}	number of calculation nodes in radial direction	[-]
Es	Eskilson number, dimensionless time	[-]
f	grid factor for the calculation grid in radial direction	[-]
g	g-function, dimensionless thermal response of the earth by Eskilson	[-]
H	borehole length, borehole depth	[m]
\dot{m}	mass flow rate, mass flow rate in the boreholes	[kg/s]
m	number of calculation nodes in the radial direction (=DimRad)	[-]
Nu	Nusselt number	[-]
Pr	Prandtl number	[-]
Δp	pressure drop	[Pa]
\dot{q}	specific heat extraction rate of the borehole per length	[W/m]
\dot{q}_{geo}	natural, undisturbed geothermal heat flow	[W/m ²]
Δq_i	heat loss of the upward flowing fluid to the downward flowing fluid	[W/m]
\dot{Q}	extraction rate, injection rate, power	[W]
Re	Reynolds number	[-]
r_0	inner radius of the borehole pipe	[m]
r_s	outer radius of the borehole pipe	[m]
r_i	inner radius of the inner coaxial borehole pipe	[m]
r_a	outer radius of the inner coaxial borehole pipe	[m]
r_1	borehole radius	[m]
r_b	radial distance from the borehole axis (variable)	[m]
R_α	heat transfer resistance from the fluid to the wall of the borehole pipe	[Km/W]
R_a	internal borehole resistance (from the upward to the downward flowing fluid)	[Km/W]
R_b	thermal borehole resistance (from the fluid to the borehole radius)	[Km/W]
R_c	thermal borehole resistance (from the borehole pipe to the borehole radius), $R_c = R_b - R_\alpha$	[Km/W]
R_f	thermal resistance of the evaporator, $(T_{source} - T_f) / \dot{q}$	[Km/W]
R_m	thermal transportation resistance in the fluid between the depth H/2 and the earth surface	[Km/W]
ΔT_{Grad}	vertical temperature gradient in the undisturbed earth	[K/m]
T_b	borehole temperature in the depth z (on the radius r_1)	[°C]
\bar{T}_b	borehole temperature averaged over the borehole depth (on the radius r_1)	[°C]
T_f	mean fluid temperature in the depth z	[°C]
\bar{T}_f	averaged fluid temperature, $\frac{1}{2} (T_{outlet} + T_{inlet})$	[°C]
T_{down}	temperature of the downward flowing fluid in the depth z	[°C]
\bar{T}_{Air}	longtime mean temperature of the outer air	[°C]
T_m	mean temperature of the undisturbed earth	[°C]
T_{mo}	averaged, annual temperature on the earth's surface	[°C]
T_{outlet}	outlet temperature (temperature of the out streaming borehole fluid)	[°C]
T_{inlet}	inlet temperature (temperature of the inflowing borehole fluid)	[°C]
T_{up}	temperature of the upward flowing fluid on the depth z	[°C]
t_s	borehole time constant	[s]

v	flow velocity	[m/s]
w	wall thickness of the inner pipe of a coaxial borehole ($r_a - r_i$)	[m]
z	depth in the earth, measured from the earth's surface	[m]

7.2 Greek symbols

α	heat transfer coefficient of the borehole fluid	[W/(m ³ K)]
β	dimensionless thermal resistance from the borehole pipe to the fluid	[-]
ξ	dimensionless pressure loss coefficient (pipe friction number, often λ)	[-]
γ	Euler constant, 0.5772..	[-]
ν	kinematic viscosity of the borehole fluid	[m ² /s]
λ_{Earth}	heat conductivity of the earth	[W/(mK)]
λ_{Fill}	heat conductivity of the borehole filling	[W/(mK)]
λ_{isol}	heat conductivity of the isolated borehole pipe	[W/(mK)]
λ_{s}	heat conductivity of the borehole pipe	[W/(mK)]
λ_{w}	heat conductivity of the inner pipe of a coaxial borehole	[W/(mK)]
σ	conductivity parameter of the borehole filling	[-]

8 Literature

- [1] Carslaw, H.S.; Jaeger, J.C. (1959): **Conduction of heat in solids**. 2nd ed., Oxford Univers. Press, London.
- [2] Claesson, J.; Eskilson, P. (1987): **Conductive Heat Extraction by a Deep Borehole. Analytical Studies**. Dep. of Mathematical Physics, University of Lund.
- [3] Eskilson, P. (1987): **Thermal Analysis of Heat Extraction Boreholes**. Department of Mathematical Physics, Lund Institute of Technology, Lund, Sweden. ISBN 91-7900-298-6
- [4] Hellström, G. (1991): **Ground Heat Storage. Thermal Analyses of Duct Storage Systems. Theory**. Dep. of Mathematical Physics, University of Lund, Sweden. ISBN 91-628-0290-9
- [5] Huber, A.; Schuler, O. (1997): **Berechnungsmodul für Erdwärmesonden**. Forschungsprogramm Umgebungs- und Abwärme, Wärmekraftkopplung. Bundesamt für Energie, Bern.
- [6] Huber, A.; Pahud, D. (1999b): **Erweiterung des Programms EWS für Erdwärmesondenfelder**. Schlussbericht. Bundesamt für Energie (BFE), Bern.
- [7] Huber, A. (1999): **Hydraulische Auslegung von Erdwärmesondenkreisläufen**. Schlussbericht. Bundesamt für Energie (BFE), Bern.
- [8] Huber, A. (2005): **Erdwärmesonden für Direktheizung. Phase 1: Modellbildung und Simulation**. Schlussbericht. Bundesamt für Energie (BFE), Bern.
- [9] Huber, A. (2006): **Rechenmethode WPEsti: Modellbeschrieb**. Verein MINERGIE (<http://www.minergie.ch>), AWEL (<http://www.energie.zh.ch>), FWS (<http://www.fws.ch>). Zürich, 31. Mai 2006.
- [10] Huber, A. (2006): **Planung von gekoppelten Kälte- und Wärme-Erzeugungsanlagen mit Erdwärmesonden**. Weiterbildungskurs 235, Hochschule für Technik+Architektur, Luzern
- [11] Leu, W.; Keller, G.; Mégel, Th.; Schärli, U.; Rybach, L. (1999): **Programm SwEWS-99. Berechnungsprogramm für geothermische Eigenschaften der Schweizer Molasse (0-500m)**. Schlussbericht. Bundesamt für Energie, Bern.
- [12] Leu, W.; Keller, G.; Matter, A.; Schärli, U.; Rybach, L. (1999): **Geothermische Eigenschaften Schweizer Molassebecken (Tiefenbereich 0-500m)**. Bundesamt für Energie, Bern.
- [13] Merker, G. (1987): **Konvektive Wärmeübertragung**. Springer-Verlag.
- [14] Werner, A.; Bigler, R.; Niederhauser, A. et. al. (1996): **Grundlagen für die Nutzung von Wärme aus Boden und Grundwasser im Kanton Bern. Thermoprogramm Erdwärmesonden, Burgdorf**. Schlussbericht. Wasser- und Energiewirtschaftsamt des Kt. Bern (WEA).
- [15] Huber, A.; Ochs, M. (2007): **Hydraulische Auslegung von Erdwärmesondenkreisläufen Mit der Software „EWSDruck“ Vers. 2.0**. Bundesamt für Energie, Bern.
- [16] Schärli, U.; Rohner, E.; Signorelli, S.; Wagner, R. (2007): **Thermische Leitfähigkeit: Eichung von in-situ Messungen (d.h. „kabellose Temperatursonde“) mit Laborbestimmungen als Grundlage für die geothermische Kartierung des Kanton ZH und der umliegenden Kantone**. Bundesamt für Energie, Bern.
- [17] Loose, P. (2007): **Erdwärmennutzung. Versorgungstechnische Planung und Berechnung**. 2. Auflage. C.F. Müller-Verlag. ISBN 978-3-7880-7811-9.
- [18] **Norm SIA 384/6 (2010): Erdwärmesonden**. SIA Zürich.